

A large, light gray world map composed of a grid of dots, serving as a background for the main text.

Fire Alarm System

The Intelligent Solution





Parent Company Carrier

GST's parent company, Carrier, is a world leader in HVAC, Refrigeration, Fire & Security solutions headquartered in Florida, USA. For over a century, we have been developing innovative products and services that have changed the way people live and work. That drive for innovation continues today with a renewed focus on creating solutions that will change the world for the better. At Carrier, we see possibilities in everything.

Our fire and security business encompasses a wide range of residential, commercial and industrial systems, including fire and carbon monoxide detection, alarm signaling, incident management, evacuation, monitoring; fire, gas and water mist suppression, fire and gas safety solutions, and HVAC, industrial equipment controls. In addition, from a security standpoint, we offer access control and event monitoring, electronic locks, hospitality solutions, mobile apps and credentialing, real estate access solutions, remote access management and video management.

Gulf Security Technology Co., Ltd. (GST)

Gulf Security Technology Co., Ltd, GST, is a key player in the Asia fire and security industry and a trusted provider of comprehensive fire system solutions around the world. It is a subsidiary of Carrier (Carrier Global Corporation), a leading global provider of innovative HVAC, refrigeration, fire, security and building automation technologies.

GST provides a wide range of fire products and customized fire system solutions tailored to the needs of different industries. With a sales infrastructure that covers many countries and regions, and includes a China-wide network of more than 120 sales offices and several logistics centers, GST has become an important part of Carrier's global business.

To satisfy the needs of its global customer base, GST has established extensive R&D facilities in Beijing and Qinhuangdao in northern China. It constantly strives to develop innovative new

technologies and products. GST's factory in Qinhuangdao is a large manufacturing base producing intelligent electronic products that incorporate innovative technology. To ensure superior product quality, it has advanced manufacturing and inspection equipment and strong capabilities in quality control and process management.

GST has earned a range of national and international certificates of conformity to standards such as China's CCC, the international UL, the global LPCB, Europe's CE, etc.



Contents

- P01 / EN54 Addressable Products*
- P19 / EN54 Conventional Products*
- P28 / UL Listed Products*
- P44 / Gas Release Control Products*
- P48 / Explosion Proof Products*
- P55 / Gas Detector*
- P57 / Power Supply Unit*
- P59 / Specified Detector*
- P61 / Value Added Unit*
- P63 / System Diagram*
- P68 / Emergency Voice Evacuation*
- P78 / Emergency Telephone Products*

EN54 Addressable Products

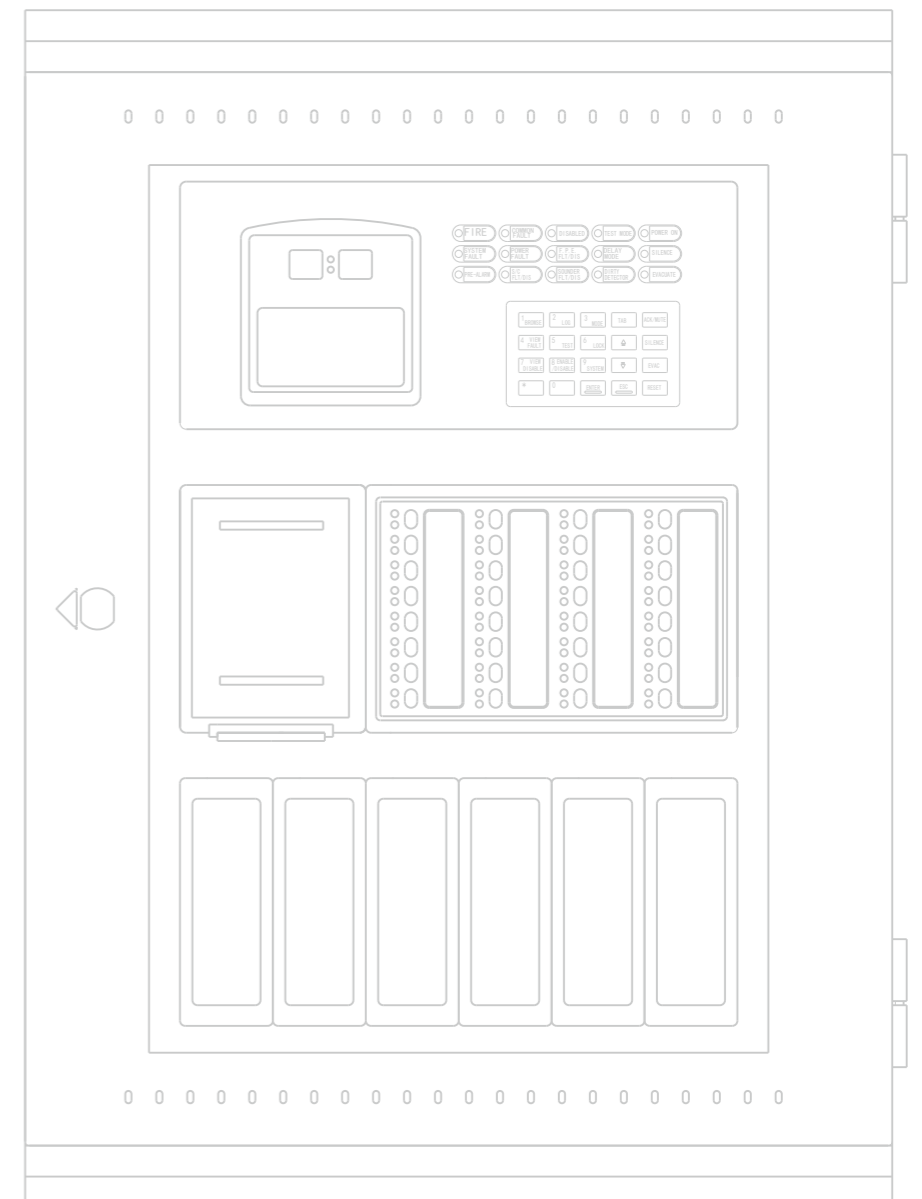



GST200N

Intelligent Fire Alarm Control Panel

Overview

GST200N Intelligent Fire Alarm Control Panel includes GST200N-1, and GST200N-2. GST200N-1 is single loop panel, possible to be expanded the 2-loop version GST200N-2. They are suitable for small buildings like office, restaurant, store, shop, etc., provide simple installation, operation, and easy maintenance.

Features

- Wide range power supply, 100-240VAC, 50-60Hz
- Max. 30 zones. Each zone has its own alarm and fault/disable indicator and a label
- Capacity 235 addressable devices
- Optional expanded to 2 loops, 477 loop devices
- Compatible with GST intelligent and digital products
- 8X18 characters LCD screen
- Non-Volatile memory ensures the data does not loss even if power supply is accidentally removed

Models

Model number	Description
GST200N-1	Single loop, English
GST200N-2	Dual loops, English
GST200N-HU	Single loop, Hungarian
GST200N-PT	Single loop, Portuguese
GST200N-SP	Single loop, Spanish
GST200N-IT	Single loop, Italian
GST200N-FR	Single loop, French
GST200N-TK	Single loop, Turkish
GST200N-RO	Single loop, Romanian

LC200

Loop Card For additional 2nd loop



P-9905

USB Printer Interface



P-9930

RS232 card for PC connection



P-9960

CAN Class B Network Card



P-9930ModBus

ModBus Card for 3rd party interfacing



P-9960A

CAN Class A Network Card



P-9930TCPIP

TCP/IP Network Card



P-9901A

Panel Printer





GST-IFP8

Intelligent Fire Alarm Control Panel

Overview

GST-IFP8 Intelligent Fire Alarm Control Panel is modularized multi-loop model, can be expanded to 8 loops (Max. 10 loops without network function). The panel is suitable for small to medium projects.

Features

- Max.999 zones, 140 have individual alarm and fault/disable LEDs and a label
- 8 Class A loops, total capacity of 1936 devices
- 15X40 LCD screen, assisting the 17 LEDs to display important information
- Compatible with full series of GST addressable and digital products
- Non-Volatile memory ensures the data does not loss even if power supply is accidentally removed

Models

Model number	Description
GST-IFP8	English
GST-IFP8-PT	Portuguese
GST-IFP8-HU	Hungarian
GST-IFP8-FR	French
GST-IFP8-IT	Italian
GST-IFP8-SP	Spanish
GST-IFP8-TK	Turkish

LCIFP8

Dual-Loop Card For additional loops



P-9945RP

RS485 Repeater Card



P-9935

RS232 card for PC connection



P-9965

CAN Class B Network Card



P-9935ModBus

ModBus Card for 3rd party interfacing



P-9965A

CAN Class A Network Card



P-9935TCPIP

TCP/IP Network Card



P-9904

USB Printer Interface





GST-NRP00

Network Repeater Panel

Overview

GST-NRP00 Network Repeater Panel is based on GST network technology, providing remote control and indication of the fire alarm system.

Features

- Provide remote display and control of system
- Password protected access levels
- 8X18 characters LCD screen
- 15 LEDs to display important information
- Functional control of network panels
- Network-wide operation: Acknowledge, Silence, Reset
- Flush-mount or surface-mount structure
- Meet network protocol by selecting suitable network card

P-9960

CAN Class B Network Card



P-9960A

CAN Class A Network Card



GST852RP

LCD Repeater Panel

Overview

GST-852RP repeater panel is a remote indication unit of GST addressable system. In case of fire, the repeater panel will display the fire type, time and location details together with sound for local notification. This addressable repeater is possible to be connected with GST addressable panels through RS485 links.

Features

- Big size LCD display with backlight
- Compatible with all GST intelligent panels
- Mute and lamp test
- Electrically addressing



GST8903

Intelligent Graphic Repeater Panel

Overview

GST8903 graphic repeater panel (MIMIC panel) is a remote indication unit of GST addressable system. In case of fire or fault, the repeater panel will show the message by specified LED in certain position of the layout drawing, indicating the exact location clearly. This addressable repeater is possible to be connected with GST addressable panels through RS485 links.

Features

- Up to 100 LED indication points
- Local buzzer alarm and mute
- Custom Graphical layout to project requirement
- Programmable to display zones or individual device
- Programmable to indicate Fire, action and Fault conditions
- A3, A2, A1 and A0 sizes

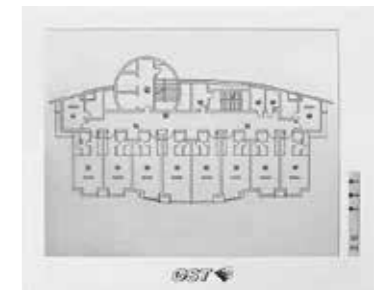

EN54 Addressable Products

DI-9101E DI-9101E-B

Intelligent Combination Heat Photoelectric Smoke Detector

The multi-sensor combines both smoke and heat detections to build fast and reliable performance. 2 smoke sensitivity levels can be set. Heat detection is based on both FT & RR.



DI-9102E

Intelligent Photoelectric Smoke Detector

The optical detector is designed based on light scattering technology with high performance chamber, suitable for detecting slow burning or smoldering fires. 2 sensitivity levels can be set.



DI-9103E

Intelligent Rate of Rise and Fixed Temperature Heat Detector

The dual heat detector can provide FT & RR fire alarm by analyzing the temperature status by semiconductor heat sensor. 3 detection classes can be set A1R, A2S & BS.

Overview

DI-91xxE series intelligent detectors adopt the latest digital loop protocol, compatible with GST intelligent fire alarm control panels. With digital communication, the detectors can raise fast alarm signal within 1 second, and much more control can be processed.

The detectors can be installed onto the common detector base DB-01. A remote indicator C-9314P can be connected to each detector.

Features

- Electrically addressed, can be modified by programmer
- Strong environmental adaptability due to drift compensation
- Self-diagnostic
- Reed switch test
- Fire LED allows 360° viewing
- LED indication for normal status can be turned off by handheld programmer

EN54 Addressable Products

C-9314P

Remote Indicator



DB-01

Common Detector Base



DB-01-B

Common Detector Base



I-9104

Intelligent Ultraviolet Flame Detector



Overview

I-9104 Intelligent Ultraviolet Flame Detector detects fire by analyzing ultraviolet radiation of flame. It's applicable to places where open fire, fire with intense flame radiation and fire without smoldering stage take place easily, as well as places where quick response to a fire is required. Used together with other detectors, it can alarm fire in time to minimize losses as much as possible. The detectors can be installed onto the common detector base DZ-03.

Features

- High sensitivity, reliable performance, dust-proof, damp-proof and corrosion-proof
- Three sensitivity levels
- Electronically addressed in field
- Built-in microprocessor stores 14 history data
- Self-diagnostic

DZ-03

Common Detector Base





I-9105R

Intelligent Reflective Beam Detector

Overview

I-9105R Intelligent Reflective Beam detector is addressable reflective infrared beam smoke detector that can be used as Addressable or Conventional. With excellent built-in microprocessor, the detector can carry out system adjustment, drift compensation of ambient data, and judgment of fire and fault through fixed algorithm. The sensitivity of the detector can be set through hand held programmer in field, to suit different application conditions. The detector is suitable to historical buildings, warehouses, large storages, shopping malls, leisure centers, exhibition halls, hotel lobbies, printing houses, clothing factories, museums and prisons. 4 reflector plates are provided in same package. Usually 1 piece is enough for distance less than 40 meters, and 4 pieces are prepared for long distance up to 100 meters

Features

- Wide operating voltage range, large monitoring areas
- Combination of the emitting and receiving part makes mounting easy and optical pathway accurate
- Built-in microprocessor enables intelligent judgment about fire alarm and fault
- The detector can calibrate easily, which ensures a single person complete adjustment in short time. It's also convenient to operate
- Self-diagnostic function can monitor the internal fault
- Drift compensation for factors changing, such as a certain of dust accumulation, positional excursion and ageing transmitter
- Electronically addressed by programmer
- Two sensitivity levels can be set in field
- Attractive and decent appearance

RF-9105R

Reflector Plate



DI-9204E

Digital Manual Call Point

Overview

DI-9204E digital manual call point adopts the latest digital loop protocol, compatible with GST intelligent fire alarm control panels. The manual call point is semi-flush mount type. A back box is supplied for surface mounting.

Features

- Re-settable (non-breaking glass) via special key
- Dual activation indication
- Electronically addressed
- Friendly installation and test
- Wiring before termination

D-92WPB

Water Proof Box

Overview

D-92WPB Weather Proof Box is for application of manual call point outdoor installation to provide weather proofing. And the weather proof box is able to protect the manual call point from unwanted activation. Furthermore, it is also an effective guard against physical damage. Internal space is designed to suit most types of European style MCP.

Features

- IP65 cover offers fully protection of manual call point
- Meets the requirement of '2 step operation'
- Clear and durable PC cover
- Surface mounting enables the installation easily
- 60mm hole distance and enough internal space to suit most types of European style MCP
- Reserved place for additional micro-switch, battery, buzzer, etc



D-92FC

Flip Cover

Overview

The D-92FC protective flip cover is installed with D series manual call point, to build a double action of the MCP, prevent from accident trigger operation.

Features

- Material: PMMA
- Dimension: 87 X 92 X 20 (mm)
- Thickness: 1.7mm



EN54 Addressable Products



DI-9309

Addressable Multi-Channel Interface

Overview

An integrated solution for application of multi-input signals, saving mounting space and installation cost. Each output channel occupies an individual address and receives start command from FACP, energizes the related relay, gives dry contact output. Each input is corresponded to one address to receive the state signal and transmit it to FACP. The quantity of channels can be set by jumpers.

Features

- Max. 16 channels of independent inputs. The quantity can be set as required
- Two channels of independent dry contact outputs
- 3-18 consecutive addresses, changing with selected channel quantity
- Power supply monitored
- Cable monitored for open circuit and short circuit



DC-9504E

Base Mount Isolator

Isolator base to replace DB-01 common base, compatible with DI series detectors

Overview

Loop Isolator is the protection facility that can isolate the trouble part from the whole loop in case of short circuit occurs, to ensure the normal operation of other parts and locate the isolated part. The base mounted isolator is compatible with DI-91xxE detectors.

Features

- Isolates faulty part of the loop in the event of a short circuit
- Automatically reset once the fault has been cleared
- LED status indicator
- Support Class A and Class B loop connection
- Maximum 128 isolators can be connected to each loop. Maximum 50 devices between two isolators.

DC-9503E

Short Circuit Isolator

Module type isolator to be installed and terminated individually



EN54 Addressable Products

DI-9300E

Digital Single Input Module

The DI-9300E digital single input module is loop powered, designed to receive normally open or normally closed switch signals, and transmitting the signals to fire alarm control panel (FACP) through signaling line circuit (SLC) loop to FACP.



DI-9301E

Digital Single Input and Output Module

The DI-9301E digital single input and output module is loop powered, occupy one or two loop addresses, provides dry contact output (normally open and/or normally closed) following command from fire alarm control panel, also possible receives N/O or N/C switch signal (dry contact) from field equipment and transmits to FACP. The input and output can be programmed to monitor and control the same or different equipment.



DI-9305E

Digital Single Riser Output Module

The DI-9305E digital single riser output module powered by loop and external power input (24VDC or 70V/100V audio signal), switches on and off the supply to end devices. Able to connect conventional VADs or voice alarm system speakers, relay capacity 2A@30VDC or maximum 60W 70V/100V audio speakers.



DI-9319E

Digital Zone Monitor Module

The DI-9319E digital zone monitor unit, occupy one address, powered by loop and external 24V, it is designed to connect conventional detectors into addressable system. When any device reports fire signal, the module will transmit the signal to the fire alarm control panel which generates fire alarm and displays the address of the module. Maximum 30 conventional detectors or manual call points can be connected to each module. The module also provides a FORM-C dry contact output with the capacity of 2A @ 30VDC



Overview

DI-93xx series modules adopt the latest digital loop protocol, compatible with GST intelligent fire alarm control panels, to interface with conventional or non-addressable equipment. The working mode of input module can be changed by hand hold programmer. It is suitable for connecting Flow Switch, Zonal Valve, Fire Pump, and etc. The zone monitor module has a wide range of active threshold, to suit most conventional detectors and manual call points. The working mode of output module can be changed by hand hold programmer. The dry contact output mode is suitable for controlling Elevator, Fire Door etc. or interfacing to 3rd party system. The power output is suitable to drive conventional notification devices. The modules are DIN-Rail or surface mount.

EN54 Addressable Products

Features

- Electrically addressed, can be modified by programmer
- Self-diagnostic
- LEDs for fault and active indication
- Loop-powered
- Digital communications with Panels
- Low power consumption
- Loop powered (except for DI-9319E and DI-9305E)
- Ground fault detection (Need to work with the compatible FACP)
- Din Rail mount, Surface mount
- LPCB and CE certified

I-9401N

Addressable Sounder Strobe

Overview

I-9401N addressable sounder strobe can give audible and visual notification signal when activated by GST intelligent fire alarm control panel, to draw attention or evacuate in case of emergency.

Features

- Red Plexiglas lens, hi-light red, striking, long-life
- Electrically addressed, can be modified by programmer
- Sound level over 80dB
- Two part plug in structure for easy installation



I-9403

Intelligent Sounder Strobe

16 programmable tones with normal/low power consumption mode, powered by loop or external 24VDC source.

Strobe provided by high intensity LED cluster

It also can be programmed works in Light or sound and Light +sound



I-9404

Intelligent Sounder

16 programmable tones with normal/low power consumption mode, powered by loop or external 24VDC source.

Overview

I-9403 Intelligent Sounder Strobe and I-9404 Intelligent Sounder are addressable notification devices, can be controlled directly by loop command following preprogrammed equations. The sounder strobe provides pre-alarm/alarm sound together with flashing high-light LED, while the sounder provides sound only.

Features

- Electrically addressed, can be modified by programmer
- Two parts construction with base mounted termination allows easy installation
- 16 programmable alarm tones
- Optional Evacuate + Alert mode
- Optional loop powered or external 24VDC powering
- Optional power saving mode or normal mode

EN54 Addressable Products

C-94DB

Deep Base

Use with I-9403 I-9404 I-9407
C-9403 C-9404 for Surface
Cable Entry



DI-9405

Addressable Sounder Base

16 programmable tones, powered by loop. Share 1 address with detector in 2-address mode, or individual control in single-address / double-address mode

Overview

DI-9405 Addressable Sounder Base and DI-9406 Addressable Flashing Beacon Base are addressable notification devices, can be controlled directly by loop command following preprogrammed equations.

The sounder bases are "sandwich" type, can be easily inserted between the standard base DB-01 and detector.

Features

- Electrically addressed, can be modified by programmer
- Three programmable modes
- 16 selectable tones
- Sandwich structure for easy installation. No additional cable required



DI-9406

Addressable Flashing Beacon Base

16 programmable tones, powered by loop. Share 1 address with detector in 2-address mode, or individual control in single-address / double-address mode
Flash light provided by high intensity LED

EN54 Addressable Products



GST100

Intelligent Fire Alarm Control Panel

Overview

A minimized single loop addressable fire panel, designed in accordance with EN54-2 standard, to achieve simple installation, operation and maintenance, which make it ideal for smaller systems.

Features

- Maximum 8 detection zones, each with independent fire LED, fault/disable LED and zone label
- Class A loop, maximum capacity of 128 addressable devices
- 122×32 lattice LCD assisting the LED indicators to display important information
- Non-volatile memory ensuring system data not lost on shutdown of power
- 3 relay outputs available which are SOUNDER OUTPUT (R+ and R-), ALARM OUTPUT and FAULT OUTPUT

P-9943

RS485 Communication Card

For connecting repeater panel or network



EN54 Addressable Products



CAN100H-4

CAN Hub

4 Routes



CAN100H-8

CAN Hub

8 Routes



CAN100H-12

CAN Hub

12 Routes



CAN100H-16

CAN Hub

16 Routes

Overview

In addressable system, GST intelligent panels can be linked by CAN network. Through CAN hub, the fire panel network can be connected in star topology.

Features

- Communication Distance: 3000 meters
- Nodes capacity of each branch: 112
- Total system capacity based on panel models
- Avoiding loop interference to affect the whole system due to isolation between trunk and branch, branch and branch



CAN100F

Fiber Optic Converter

Overview

CAN100F is used to convert CAN signal to Fiber-optic, possible to expand communication distance up to 25km.

Features

- Transmission distance extends Max. 25 km
- Preventing against electromagnetic interference



CAN100S

CAN Relay

Overview

The CAN100S is used to extend CAN network distance. And when the network nodes are over limit, the relay can expand system capacity.

Features

- Increase 3000 meters of network distance
- Expand network nodes capacity. Max. 112 nodes under each relay



P-9910B

Hand Held Programmer

Overview

In GST intelligent system, all addressable devices are electronically addressed. P-9910B Hand Held Programmer is the tool for programming. It can also be used to read the parameters and set the working mode of those devices.

Features

- Hand held unit, portable tool
- Convenience operation
- Quadruple digit alphanumeric LCD display
- Low-consumption hibernation and power saving function
- Low battery indication
- WEEE & RoHS Compliant



P-9903

Loop Relay Module

Overview

In fire alarm system, there is always requirement to expand loop distance. And when the loop runs through heavy interference area, the signal may need to be protected. The P-9903 loop relay module can provide such functions.

Features

- Enhance loop appearance of distance and reliability
- Increase 1000 meters of loop distance
- Maximum 2 pieces of relays can be connected in serial
- Opt-isolated output signal, resistant to industrial interference
- Output supports Class B loop connection only
- WEEE & RoHS Compliant

EN54 Conventional Products

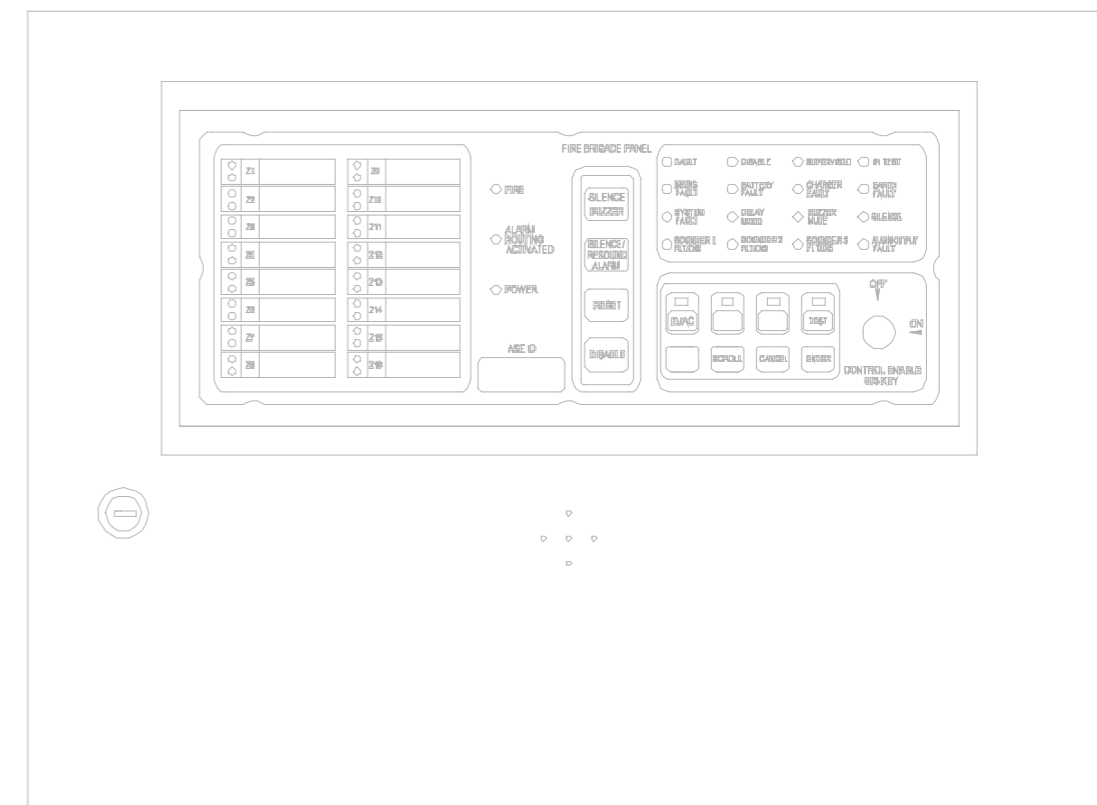

EN54 Conventional Products



GST102A

GST104A

GST108A

GST116A

Conventional Fire Alarm Panel

Overview

The A series conventional fire panels provide 2/4/8/16 conventional fire detection zone connections, meet the requirement of simple fire alarm applications. The pleasing color and fascia design makes it suitable to be installed either at the main entrance or corridor. Beside the ordinary EOLR cable monitor method, the AEOL solution can keep cable continuity even with detector removed.

The panels carry forward the feature of simplified user operation of conventional systems, also provide advanced features like Day/Night mode, Output Program, Delay Output, Repeater Link, etc.

Specification

- Mains supply, 220/230VAC, 50/60Hz
- 2/4/8/16 zones. Each zone can have maximum 32 conventional detectors
- Compatible with GST conventional products
- Options to program supervisory zones, with individual supervisory indicator and supervisory relay output
- Provide fire, fault, aux. power, sounder output and disablement relay output
- Integrated charger and battery management program, fully comply with latest EN54-4 standard requirement
- Easy operation to enable/disable zones, sounder outputs and alarm output
- Output programmable for interlink between zones and sounder outputs, alert or evacuate tone, with or without delay
- Alarm output and Fault output are available for integrating into third party system
- Reserved repeater panel interface for fire alarm indication of multiple zones
- Optional relay board to provide zone wise fire/fault relay output
- Dimension: 430mm×98mm×320mm

RB102A

Relay Board for GST102A

RB104A

Relay Board for GST104A

RB108A

Relay Board for GST108A

RB116A

Relay Board for GST116A



EN54 Conventional Products



DP-9907

Active End of Line

Compatible with DC series conventional detectors

Overview

Instead of EOLR, with Active End of Line for conventional fire detection zones, it is possible to keep the connection continuity even if a detector is removed, and provide faulty indication at the same time, so that the downstream devices of the missing detector is still operational.

The AEOL is compatible with all GST conventional panel, and compatible with addressable zone interface I-9319.

A diode base is required for each detector instead of standard base, DZ-03D is suitable for C range detectors, DB-01D is suitable for DC range detector.

EN54 Conventional Products

GST-RP16

Conventional Repeater Panel

Overview

The GST-RP16 repeater panel is compatible with GST102A/4A/8A/16A conventional panels. It is powered from FACP directly, providing Zonal Fire and general Fault indication

Specification

- Max. 16 zones
- Dimension: 280mm x 110mm x 46mm



GST101

Conventional Fire Alarm Panel

Overview

1 zone conventional fire panel suits small and temporary applications.

Specification

- Mains supply, 220/230VAC, 50/60Hz
- Zone capacity 15 conventional detectors
- Compatible with GST conventional products
- Dimension: 210mm x 297mm x 90mm



EN54 Conventional Products



DC-9101E DC-9101E-B

Conventional Combination Heat Photoelectric Smoke Detector

The multi-sensor combines both smoke and heat detections to build fast and reliable performance. 2 smoke sensitivity levels can be set. Heat detection is based on RR.



DC-9102E

Conventional Photoelectric Smoke Detector

The optical detector is designed based on light scattering technology with high performance chamber, suitable for detecting slow burning or smoldering fires. 2 sensitivity levels can be set.



DC-9103E

Conventional Rate of Rise and Fixed Temperature Heat Detector

The dual heat detector can provide FT & RR fire alarm by analyzing the temperature status by semiconductor heat sensor. 3 detection classes can be set A1R, A2S & BS.

Overview

DC-91xxE Conventional Detectors are new-generation products. With built-in microprocessor, the detectors are highly fixed with reliable fire judging program, which make it stable and reliable performance. With the new designed smoke chamber and intelligent program, the detectors have the ability of drift compensation and dust resistance. The detectors can be installed onto the common detector base DB-01. DB-01D will be suitable for connecting with Active End of Line Unit DP-9907. A remote indicator C-9314P can be connected to each detector.

Features

- Strong environmental adaptability due to drift compensation
- Self-diagnostic
- Reed switch test
- Fire LED allows 360° viewing

EN54 Conventional Products



DB-01

Common Detector Base



DB-01-B

Common Detector Base



DB-01D

Diode Detector Base

Co-operate with DP-9907, keep loop continuity even if a detector is removed.



DP-9907

Active End of Line

Co-operate with DB-01D, keep loop continuity even if a detector is removed.



C-9314P

Remote Indicator

EN54 Conventional Products



C-9104

Conventional Ultraviolet Flame Detector

Overview

C-9104 Conventional Ultraviolet Flame Detector detects fire by analyzing ultraviolet radiation of flame. It's applicable to places where open fire, fire with intense flame radiation and fire without smoldering stage take place easily, as well as places where quick response to a fire is required. Used together with other detectors, it can alarm fire in time to minimize losses as much as possible.

The detectors can be installed onto the common detector base DZ-03.

Features

- High sensitivity, reliable performance, dust-proof, damp-proof and corrosion-proof
- Self-diagnostic



DZ-03D

Diode Detector Base

Co-operate with P-9907, keep loop continuity even a detector is removed.



DZ-03

Common Detector Base



DC-9204E

Innovation Manual Call Point

Overview

DC-9204E innovation manual call point is non-addressable. It alarms by pressing the glass. It can be simply connected to compatible conventional fire alarm system from various manufacturers. This MCP is suitable for public places. When there is fire, pressing the glass on this MCP can send alarm signal to compatible conventional fire alarm control panel.

Features

- Re-settable (non-breaking glass) via special key
- Dual activation indication
- Friendly installation and test
- Wiring before termination



GST-JL

Alarm Bell

Overview

The bell has a simple structure and red coated steel casing, with novel pattern and easy installation. It is applicable to the fire alarm equipment of factory, workshop, hotel as well as large and medium sized buildings, provides clear and continuous alarm sound.

Features

- 24VDC power, 23mA operation
- 6" bell, 95dB@3m

C-9401N

Conventional Sounder Strobe

Overview

C-9401N conventional sounder strobe can give audile and visual notification signal when powered by 24VDC, to draw attention or evacuate in case of emergency.

Features

- Red Plexiglas lens, hi-light red, striking, long-life
- Sound level over 80dB
- Two part plug in structure for easy installation



C-9403

Conventional Sounder Strobe

2 selectable tones
Strobe provided by high intensity LED cluster

Overview

C-9403 Conventional Sounder Strobe and C-9404 Conventional Sounder are notification devices, provide audile/visual warning signals when 24VDC supplied.

Features

- Two parts construction with base mounted termination allows easy installation
- 2 selectable alarm tones



C-9404

Conventional Sounder

2 selectable tones

C-94DB

Deep Base

Use with I-9403
I-9404 C-9403
C-9404 for
Surface Cable
Entry



UL Listed Products

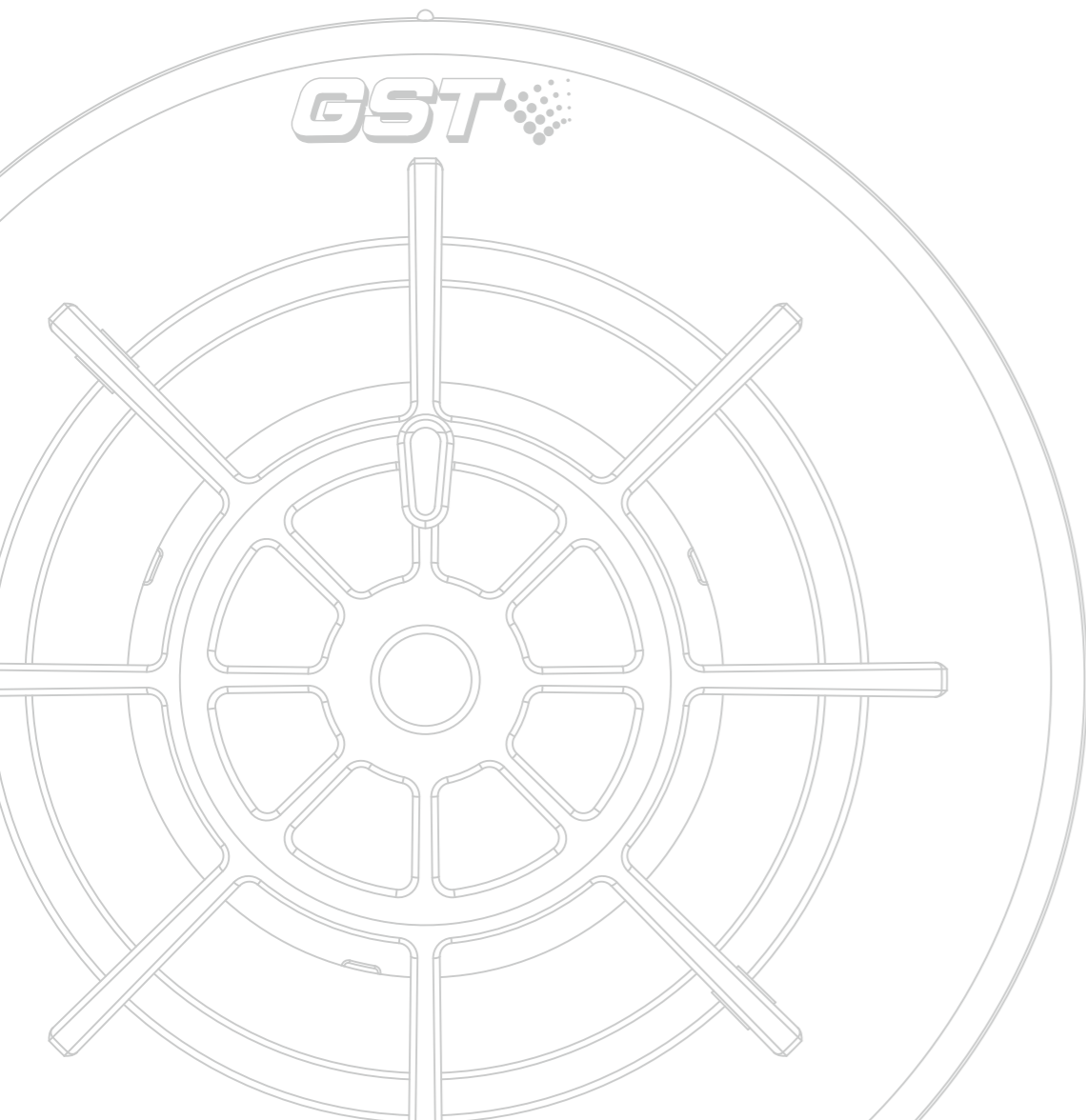

UL Listed Products



GST-IFP4M GST-IFP4M-S GST-IFP4M-S-R

Intelligent Fire Alarm Control Panel

Overview

GST-IFP4M Series Intelligent Fire Alarm Control Panel complies with UL864 standard with features of easy installation, operation and maintenance. All circuit boards are installed in a metal cabinet optional in red or grey color, providing a complete fire control system for most applications. Modularized structure allowed the panel possible to meet different requirements by adjusting the configuration.

Features

- 7-inch Touch Screen
- Wide range power supply 100-240V 50/60Hz
- Multi languages: Standard English language and other regional languages
- Support 1-6 loops in Class A style (additional battery box is required for 5 or 6 loops application)
- 242 addressable devices per loop mixing various types of devices, Max. 1452 addresses
- History records of 100,000 events
- 2 Power Limited Class B Notification Appliance Circuits (NAC), total load Max.2.5A/24VDC. The 2nd NAC can be set as AUX.
- "Walk test", silent or audible
- PAS (Positive Alarm Sequence) per point
- Report device type mismatch and duplicated loop address
- CAN/Fiber Networking, Panel grouping
- Connecting with BMS via Modbus Card

UL Listed Products

LC401

Single Loop Card



LC402

Dual Loops Card



P-9966A

CAN Class A Network Card



P-9983

Fibre Network Card



P-9956-ModBus

ModBus Card for 3rd party interfacing



MP-401

Redundancy CPU Card



P-9981

Zone Display Panel



P-9981F

Zone Display Panel



P-9982

Zone Display and Control Panel



P-9982F

Zone Display and Control Panel



UL Listed Products

PR-400B

Thermal Printer

PR-400B Thermal Printer is optional part for GST-IFP4M series fire panel, connected through RS232. It can print all or customized real time system events or system log of the control panel manually or automatically, easy to operate and convenient for checking.



GST-MNA2C

Network Annunciator

GST-MNA2C Network Annunciator is an intelligent fire annunciator to connect with GST-IFP4M panel via CAN network, easy for installation, operation, and maintenance. The powerful CPU, inbuilt Linux OS and touch-screen provide a user-friendly operation interface.

Features

- Receive message and send command (Reset, Silence, ACK etc.) through network
- Network interface: CAN, Class A
- LCD display unit of 800 x 480, 7.0" color TFT LCD
- Capacitive Touch screen
- History file 100,000 events capacity
- Password and key-protected nonvolatile memory
- User programmable password
- Field-programmable, or by pc with GST-IFPx-Def Defining Tool



GST-MNA2F

Network Annunciator

GST-MNA2F Network Annunciator is an intelligent fire annunciator to connect with GST-IFP4M panel via Fiber-Optic network, easy for installation, operation, and maintenance. The powerful CPU, inbuilt Linux OS and touch-screen provide a user-friendly operation interface.

Features

- Receive message and send command (Reset, Silence, ACK etc.) through network
- Network interface: Fiber-Optic, Class-A type
- LCD display unit of 800 x 480, 7.0" color TFT LCD
- Capacitive Touch screen
- History file 100,000 events capacity
- Password and key-protected nonvolatile memory
- User programmable password
- Field-programmable, or by pc with GST-IFPx-Def Defining Tool



UL Listed Products



GST-M200

Intelligent Fire Alarm Control Panel

Single loop fire alarm control panel, adopts GST digital loop protocol to build intelligent fire alarm system. The wall-mounted FACP is suitable for small to medium project. The panel is possible to be powered by 100VAC to 230VAC, 50/60Hz.

Overview

GST-M200 is single loop intelligent fire alarm control panel. Class A loop can drive maximum 242 addresses. With LC200 loop card, the 2nd loop will expand system extra 242 addresses. The panel is programmable by keypad, or by PC through P-9930 communication card. To link with 3rd party system, the P-M9930Modbus card can provide data buffer for status of each device.

Features

- 2 Style Y Notification Appliance Circuits (NAC)
- 3 fixed relay outputs for fire/fault/supervisory
- Optional USB printer interface
- Optional graphic monitor station connection
- Walk Test function
- Positive Alarm Sequence (PAS) per point
- Advanced user friendly programming software including 'Fuzzy Logic'

LC200

Loop Card



P-9930

RS232 Communication Card



P-M9930Modbus

RS232 ModBus Communication Card



UL Listed Products



DI-M9101

Intelligent Combination Heat Photoelectric Smoke Detector

The multi-sensor combines both smoke and heat detections to build fast and reliable performance. 2 smoke sensitivity levels can be set. Heat detection is based on both FT & RR.



DI-M9102

Intelligent Photoelectric Smoke Detector

The optical detector is designed based on light scattering technology with high performance chamber, suitable for detecting slow burning or smoldering fires.



DI-M9103

Intelligent Rate of Rise and Fixed Temperature Heat Detector

The dual heat detector can provide FT & RR fire alarm by analyzing the temperature status by semiconductor heat sensor. Rate of rise detection can be switched off for certain applications.

Overview

DI-M91xx series UL listed intelligent detectors adopt the latest digital loop protocol, compatible with GST UL listed intelligent fire alarm control panels. With digital communication, the detectors can raise fast alarm signal within 1 second, and much more control can be processed. The detectors can be installed onto the common detector base DB-M01. A remote indicator C-9314P can be connected to each detector.

Features

- Electrically addressed, can be modified by programmer
- Strong environmental adaptability due to drift compensation
- Self-diagnostic
- Reed switch test
- Fire LED allows 360° viewing
- LED indication for normal status can be turned off by handheld programmer

C-9314P

Remote Indicator (With BP-9314 Back Plate)



DB-M01

Common Detector Base



UL Listed Products

DI-M9300

Digital Single Input Module

The DI-M9300 single input module is designed to receive normally open or normally closed switch signals, and transmitting the signals to fire alarm control panel (FACP) through signaling line circuit (SLC) loop to FACP.



DI-M9301

Addressable Single Output Module

DI-M9301 Digital Single Input and Output Module provides dry contact output (normally open and/or normally closed) following command from fire alarm control panel, also possible receives switch signal (dry contact) from field equipment and transmits to FACP. The input and output can be programmed to monitor and control the same or different equipment.



DI-M9305

Digital Single Riser Output Module

DI-M9305 Digital Single Riser Output Module is designed to control the powering route, switches on and off the supply to end devices.



UL Listed Products

DI-M9319

Digital Zone Monitor Module

The DI-M9319 Digital Zone Monitor Module is designed to connect conventional detectors into addressable system. When any device reports fire signal, the module will transmit the signal to the fire alarm control panel which generates fire alarm and displays the address of the module. Maximum 30 conventional detectors or manual call points can be connected to each module. The module also provides a FORM-C dry contact output with the capacity of 2A @ 30VDC, 0.35PF



Overview

DI-93xx series modules adopt the latest digital loop protocol, compatible with GST intelligent fire alarm control panels, to interface with conventional or non-addressable equipment.

The working mode of input module can be changed by hand hold programmer. It is suitable for connecting Flow Switch, Zonal Valve, Fire Pump, and etc.

The zone monitor module has a wide range of active threshold, to suit most conventional detectors and manual call points. The working mode of output module can be changed by hand hold programmer. The dry contact output mode is suitable for controlling Elevator, Fire Door, etc or interfacing to 3rd party system. The power output is suitable to drive conventional notification devices.

The modules are DIN-Rail or surface mount.

Features

- Electrically addressed, can be modified by programmer
- Self-diagnostic
- LEDs for fault and active indication
- Digital communications with Panels
- Low power consumption
- Loop powered
- Ground fault detection (Need to work with the compatible FACP)
- Din Rail mount, Surface mount
- UL864, NFPA [70, 72] approved

GST-MBX22 GST-MBX29

Module Box

GST-MBX22 and GST-MBX29 module boxes are optional accessories for both UL and LPCB D series din-rail mount modules centralize installation, include mounting strip and cable trunking. GST-MBX22 able to store up to 10 pcs small size or 6 pcs big size modules, GST-MBX29 able to store up to 20 pcs small size or 12 pcs big size modules.



D-93TC1

Din-rail Module Transparent Cover 1U

D-93TC1 is the optional transparent cover for 1 U size module (DC-9503E, DI-9300E, DC-M9503 and DI-M9300) to cover the module and terminals



D-93TC2

Din-rail Module Transparent Cover 2U

DC-93TC2 is the optional transparent cover for 2U size module (DI-9301E, DI-9305E, DI-9319E, DI-M9301, DIM9305 and DI-M9319) to cover the module and terminals



DI-M9204

Digital Manual Call Point



Overview

DI-M9204 digital manual call point adopts the latest digital loop protocol, compatible with GST UL listed intelligent fire alarm control panels. The manual call point is semi-flush mount type. A back box is supplied for surface mounting.

Features

- Re-settable (non-breaking glass) via special key
- Dual activation indication
- Electronically addressed
- Friendly installation and test
- Wiring before termination



DC-M9503

Short Circuit Isolator

Module type isolator to be installed and terminated individually



DC-M9504

Base Mount Short Circuit Isolator

Base type isolator can be used as a detector base, or stand alone with a cover

Overview

Loop Isolator is the protection facility that can isolate the trouble part from the whole loop in case of short circuit occurs, to ensure the normal operation of other parts and locate the isolated part. The base mounted isolator is compatible with DI-M91xx detectors.

Features

- Isolates faulty part of the loop in the event of a short circuit
- Automatically reset once the fault has been cleared
- LED status indicator
- Support Class A and Class B loop connection
- Maximum 128 isolators can be connected to each loop. Maximum 50 devices between two isolators.

UL Listed Products



DC-M9101

Conventional Combination Heat Photoelectric Smoke Detector

The multi-sensor combines both smoke and heat detections to build fast and reliable performance. 2 smoke sensitivity levels can be set. Heat detection is based on fixed temperature.

Overview

DC-M91xx series UL listed conventional detectors are 2-wire type, alarm equivalent resistance 680Ω, possible to build fire alarm system together with UL listed conventional panels or addressable modules. The detectors can be installed onto the common detector base DB-M01. A remote indicator C-9314P can be connected to each detector.

Features

- Sensitivity levels can be modified by programmer
- Strong environmental adaptability due to drift compensation
- Self-diagnostic
- Reed switch test
- Fire LED allows 360° viewing
- LED indication for normal status can be turned off by handheld programmer

C-9314P

Remote Indicator
(With BP-9314 Back Plate)



DC-M9102

Conventional Photoelectric Smoke Detector

The optical detector is designed based on light scattering technology with high performance chamber, suitable for detecting slow burning or smoldering fires.



DC-M9103

Conventional Rate of Rise and Fixed Temperature Heat Detector

The dual heat detector can provide FT & RR fire alarm by analyzing the temperature status by semiconductor heat sensor. Rate of rise detection can be switched off for certain applications.

DB-M01

Common Detector Base



UL Listed Products

DC-M9204

Innovation Manual Call Point

Overview

DC-M9204 conventional manual call point is compatible with UL listed conventional panels or addressable modules. The manual call point is semi-flush mount type. A back box is supplied for surface mounting.

Features

- Re-settable (non-breaking glass) via special key
- Dual activation indication
- Friendly installation and test
- Wiring before termination



DI-M9402

Intelligent Sounder Base



Overview

DI-M9402 intelligent sounder base are loop powered products, electrically addressed, compatible with DI-M910x series detectors and GST-IFPxM series fire alarm control panels, provide panel level synchronized audio output after activated.

Features

- Plugged together with a fire detector
- Sound Pressure Level ≥85dB
- Sound Frequency 3100Hz

DC-M9402

Conventional Sounder Base



Overview

DC-M9402 conventional sounder base compatible with DI-M910x or DC-M910x series detectors and GST-IFPxM series fire alarm control panels, driven by panel NAC output or DI-M9305 single riser module output provide synchronized audio output after activated.

Features

- Plugged together with a fire detector
- Sound Pressure Level ≥85dB
- Sound Frequency 3100Hz

UL Listed Products



DC-M9413 Series Sounder Strobe

Wall Mount Sounder Strobe

Overview

The DC-M9413 Series Wall Mount Sounder Strobe is a fire alarm notification appliance that is designed for indoor use.

Features

- Field-configurable options for selecting dB output, sounder signal, and strobe signal output.
- Field-configurable switch for selecting the desired candela output.
- The candela output setting is locked in place and remains visible after final installation.
- This strobe features an enhanced synchronization circuit to comply with the latest requirements of UL 1971 Signaling Devices for the Hearing Impaired.
- Synchronized operation requires that you connect the DC-M9413 Series Wall Mount Sounder Strobe to a NAC output set for Synch Mode, or to a separate DC-M9410 Signal Synchronization Module.

Models

Model number	Description
DC-M9413R	Sounder-strobe, red
DC-M9413W	Sounder-strobe, white

UL Listed Products



DC-M9414 Series Sounder

Wall Mount Sounder

Overview

The DC-M9414 Series Wall Mount Sounder is an audible fire alarm notification appliance that is designed for indoor use.

Features

The DC-M9414 Series Wall Mount Sounder includes field-configurable jumper options for selecting:

- Temporal or steady sounder output
- High dB or low dB output

Models

Model number	Description
DC-M9414R	Sounder, red
DC-M9414W	Sounder, white



DC-M9415 Series Strobe

Wall Mount Strobe

Overview

The DC-M9415 Series Wall Mount Strobe is a visible fire alarm notification appliance that is designed for indoor use.

Features

- Field-configurable switch for selecting the desired candela output.
- Field-configurable jumper for the strobe signal output.
- The candela output setting is locked in place and remains visible after final installation.
- This strobe features an enhanced synchronization circuit to comply with the latest requirements of UL 1971 Signaling Devices for the Hearing Impaired.
- Synchronized operation requires that you connect the DC-M9415 Series Wall Mount Strobe to a NAC output set for Synch Mode, or to a separate DC-M9410 Signal Synchronization Module.

Models

Model number	Description
DC-M9415R	Strobe, red
DC-M9415W	Strobe, white

DC-M9416 Series Sounder Strobe

Ceiling Mount Sounder Strobe

Overview

The DC-M9416 Series Ceiling Mount Sounder Strobe is a fire alarm notification appliance that is designed for indoor use.

Features

- Field-configurable options for selecting the desired dB output, temporal or steady sound output, and strobe signal output.
- Field-configurable switch for selecting the desired candela output.
- The candela output setting is locked in place and remains visible after final installation.
- This strobe features an enhanced synchronization circuit to comply with the latest requirements of UL 1971 Signaling Devices for the Hearing Impaired.
- Synchronized operation requires that you connect the DC-M9416 Series Ceiling Mount Sounder Strobe to a NAC output set for Synch Mode, or to a separate DC-M9410 Signal Synchronization Module.



Models

Model number	Description
DC-M9416R	Sounder-strobe, red, with FIRE marking
DC-M9416W	Sounder-strobe, white, with FIRE marking

DC-M9410

Signal Synchronization Module

The DC-M9410 Signal Synchronization Module provides precision synchronization for the following sounders and strobes:

- DC-M9413 Series wall mount sounder strobes
- DC-M9414 Series wall mount sounders
- DC-M9415 Series wall mount strobes
- DC-M9416 Series ceiling mount sounder strobes



Gas Release Control Products



GST301

Conventional Gas Extinguishing Control Panel

Overview

The GST301 is standalone gas extinguishing control panel, provides 2 conventional detection zones to achieve double knock control, and an additional standard fire detection zone for other areas. The Duty and Standby Cylinder control can be automatic and manual controlled, with adjustable delay timer

The Built-in PSU and Charger can support 24 hours standby and 30 minutes activation period.

Specification

- Mains supply: 220/230VAC, 50/60Hz
- Backup Battery: 7AH/24VDC
- Sounder Output: 0.5A/24VDC
- Release Output: 2A/24VDC, Pulse
- Dimension: 300mm x 350mm x 110mm

**Gas Extinguishing
DO NOT ENTER**



GST303

Addressable Gas Extinguishing Control Panel

Overview

The GST303 and GST306 addressable gas extinguishing control panels are compatible with all GST intelligent fire alarm control panels, provide 3 or 6 protection zone outputs.

The gas panel sits directly on addressable loop, achieving extinguishing control by carrying out the intelligent equations on the fire panel.

External 24VDC power supply is required.

Specification

- Mains supply: 24VDC
- Cylinder Output: Pulse (5s) or Continuous output, Max. 2A
- Release Indicator: 300mA/24VDC
- Sounder Output: Dry-contact, 1A/24VDC
- Dimension: 385mm x 444mm x 14mm
575mm x 444mm x 14mm

GST306

Addressable Gas Extinguishing Control Panel

C-9317

Emergency Gas Override Control

C-9317 Emergency Gas Override Control is used to control the start and stop of gas extinguishing system, usually installed in areas to be protected.

The control button is compatible with GST301 conventional and GST303/306 addressable gas release control panels
Dimension: 144mm x 90mm x 58.5mm



C-9318

Gas Extinguishing Warning Indicator

C-9318 Gas Extinguishing Warning Indicator is the accessory of a gas extinguishing system, usually installed above the entrance of the protected area.

The warning indicator is compatible with GST301 conventional and GST303/306 addressable gas release control panels

Mains supply: 24VDC

Dimension: 348mm x 159mm x 29mm



C-9329

Gas Extinguishing Control Relay Module

C-9329 Gas Extinguishing Control Relay Module is to co-operate with GST303 or GST306 Gas Extinguishing Control Panel, to carry out gas release solenoid control and cable monitoring.

Dimension: 120mm x 80mm x 43mm



Explosion Proof Products

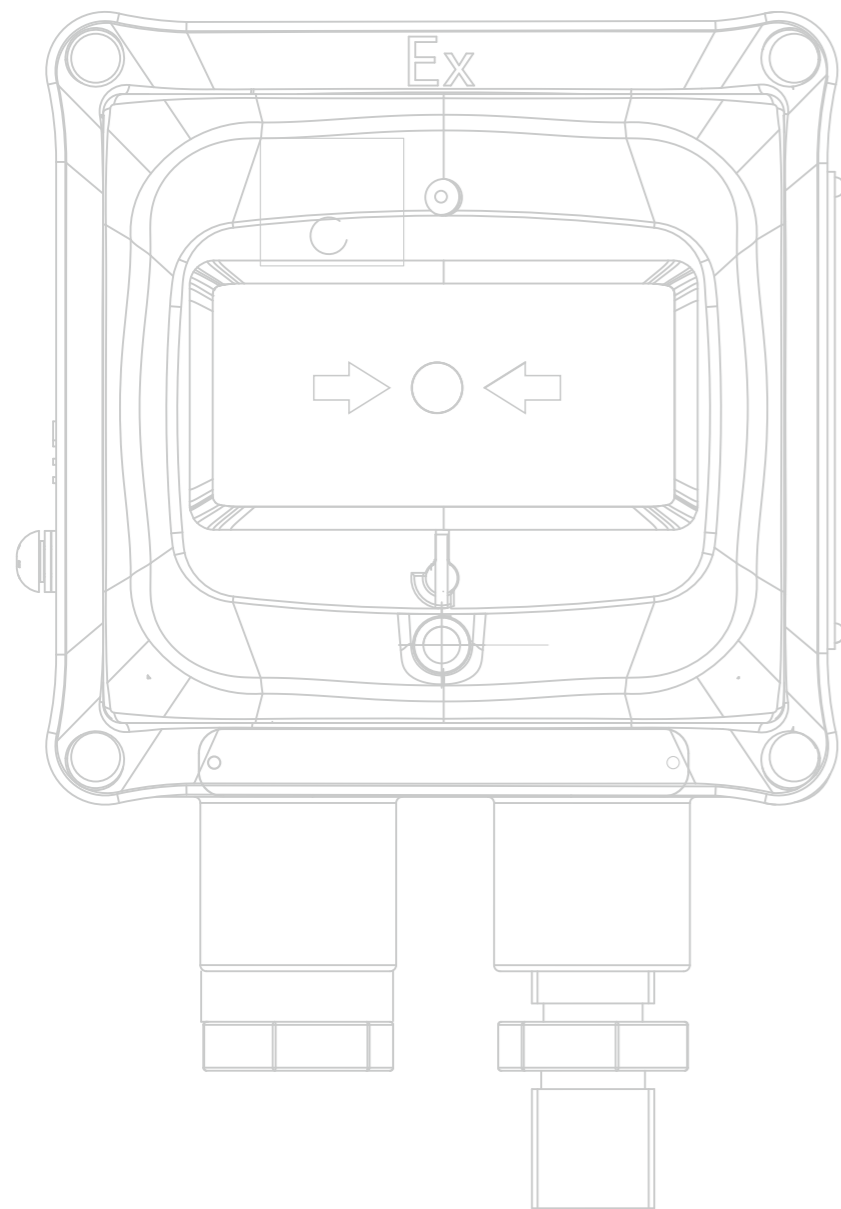

Explosion Proof Products

DI-9204Exd

Digital Flame-proof Manual Call Point





Overview

DI-9204Exd MCP is applicable to vessels, Zone 1 and 2 of explosive gas atmosphere and Zone 20, 21, and 22 of explosive dust atmosphere. It is also suitable for outdoor application.

The MCP can work at addressable mode to connect with GST's addressable FACP, or work at non-addressable mode to connect with 24VDC power and output dry-contact alarm signal.

Specification

- Operating Voltage: 24V
- Ingress Protection: IP65
- Material: ZL102 aluminum alloy, red
- Dimension: 219mm x 129mm x 95mm
- Ex Mark:  II 2 G Ex db IIB T6 Gb, -40°C ≤ T_a ≤ +70°C
-  II 2 D Ex tb IIIC T80°C Db
- ATEX Certificate: Presafe 14 ATEX 5549X

D-9105RExd

Digital Flame Proof Reflective Beam Detector



Overview

D-9105RExd Beam Detector is applicable to either commercial areas or hazardous industrial areas, such as Zone 1 and 2 of explosive gas areas and Zone 21 and 22 of combustible dust areas.

The detector is able to be used as addressable mode connecting in GST fire alarm loop, or non-addressable mode providing dry contact outputs for fire and fault conditions.

Specification

- Operating Voltage: 24V
- Ingress Protection: IP66
- Material: Stainless steel, metallic gray
- Dimension: 344mm x 240mm x 212mm
- Ex Mark: Ex dIIC T6 Gb/Ex tD A21 IP66 T85 C
- Ex Certificate: CE16.1388X



DI-9104Exd

Digital Flame Proof UV Flame Detector

Overview

DI-9104Exd detects fire by picking up the ultraviolet light from flaming material. It's designed for areas where an open fire is liable to occur with large amount of radiation and no smoldering stage. This detector can be applicable to zone 1 and 2 of explosive areas. The detector is able to work either in addressable mode connecting with GST intelligent fire alarm control panel, or in non-addressable mode to transmit signal by outputting different resistance values.

Specification

- Operating Voltage: 24V
- Ingress Protection: IP66
- Material: ZL102 aluminum alloy, silvery grey
- Dimension: 147mm x 106mm x 92mm
- Ex Mark: II 2 G Ex d IIC T6 Gb, $-20^{\circ}\text{C} \leq T_a \leq +60^{\circ}\text{C}$
- ATEX Certificate: Presafe 14 ATEX 5547



D-9107RExd

Digital Flame Proof Dual IR Flame Detector

Overview

The detector uses two pyroelectric infrared sensors to detect the change of light signal of flame and background light signal at two bands of infrared spectrum through individual processing channels. The detector is applicable to explosive Zone 1 and 2, and Zone 21 or 22 with flammable dust. The detector is able to be used as addressable mode connecting in GST fire alarm loop, or non-addressable mode providing dry contact outputs for fire and fault conditions.

Specification

- Operating Voltage: 24V
- Ingress Protection: IP66
- Material: Stainless steel, metallic gray
- Dimension: 166mm x 235mm x 199mm
- Ex Mark: Ex db IIC T6 Gb
 Ex tb IIIC T80°C Db
- ATEX Certificate: Presafe 14 ATEX 5548X



DC-9101(IS)

Intrinsically Safe Combination Heat Photoelectric Smoke Detector

Ex Mark: Exib II CT6 Gb
Ex Certificate: CE11.2056
3 smoke sensitivity levels can be set.
FT and RR can be set



DC-9102(IS)

Intrinsically Safe Photoelectric Smoke Detector

Ex Mark: Exib II CT6 Gb
Ex Certificate: CE16.2158



DC-9103(IS)

Intrinsically Safe Rate of Rise and Fixed Temperature Heat Detector

Ex Mark: Exib II CT6 Gb
Ex Certificate: CE17.2124

Overview

The Intrinsically Safe Conventional Detectors are applicable to Zone 1 and Zone 2 of areas with explosion-proof requirement in petroleum and chemical industries. With explosion proof interface I-9332, the detectors can be connected into GST addressable system. Max.10 pieces (mixed) can be linked to each interface. A common base DB-01(IS) is available for the detectors.

DB-01(IS)

Intrinsically Detector Base





DC-9202(IS)

Intrinsically Safe Manual Call Point

Ex Mark: Exib II CT6 Gb
Ex Certificate: CE16.2234

Overview

The DC-9202(IS) Intrinsically Safe Conventional MCP is applicable to Zone 1 and Zone 2 of areas with explosion-proof requirement in petroleum and chemical industries.
With explosion proof interface I-9332, the detectors can be connected into GST addressable system.



DC-9403(IS)

Intrinsically Safe Conventional Sounder Strobe

Ex Mark: Exib II CT6 Gb
Ex Certificate: CE11.2146

Overview

The Intrinsically Safe Conventional Sounder/Strobe are applicable to Zone 1 and Zone 2 of areas with explosion-proof requirement in petroleum and chemical industries. With explosion proof interface I-9333, the detectors can be connected into GST addressable system. Each interface can only drive 1 sounder/strobe.



DC-9404(IS)

Intrinsically Safe Conventional Sounder

Ex Mark: Exib II CT6 Gb
Ex Certificate: CE17.2192



I-9332

Intrinsically Safe Interface

Overview

The I-9332 interface is to connecting conventional intrinsically safe detectors and MCP into GST addressable fire alarm system. Any of the following detectors and call points alarms will be reported to the panel shown as an address.
The built-in Zener Barrier provides energy limitation to the hazard area.



I-9333

Intrinsically Safe Interface

Overview

The I-9333 interface is to connecting conventional intrinsically safe sounders into GST addressable fire alarm system. Any of the following detectors and call points alarms will be reported to the panel shown as an address.
The built-in Zener Barrier provides energy limitation to the hazard area.



GST-AS-200

Zener Safety Barrier

Ex Mark: [Ex ib Gb] IIC
Ex Certificate: CE16.2010

Overview

GST-AS-200 and GST-AS-300 Zener Safety Barriers are used to associate with intrinsically safe products. It provides protection by limiting the energy into explosive environment. It ensures the energy output always be controlled under a safe value in case of any kind of fault condition.

The 2 lines of GST-AS-300 are both fused, as of GST-AS-200 has only 1-line fused.

Max. Output Voltage: $U_o=28V$

Max. Output Current: $I_o=93mA$

GST-AS-300

Zener Safety Barrier

Ex Mark: [Ex ib Gb] IIC
Ex Certificate: CE16.2010

Gas Detector

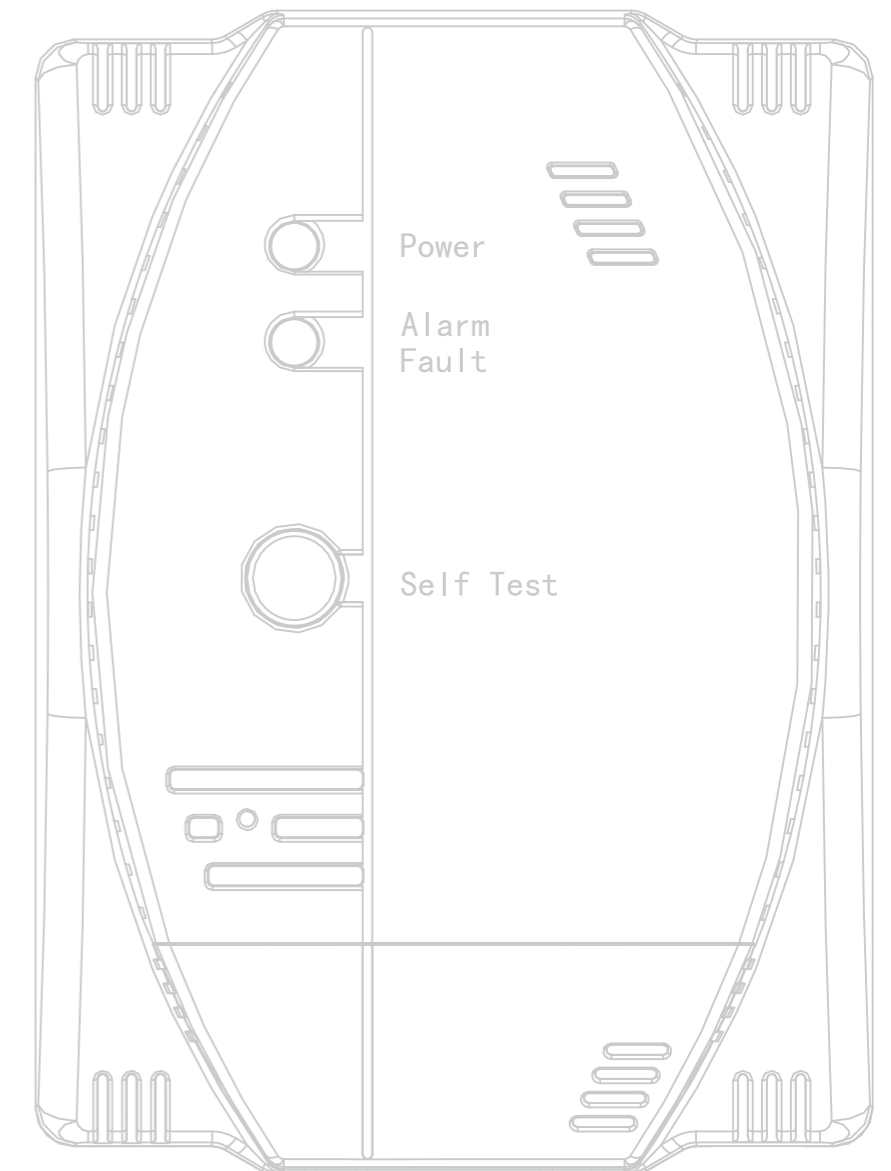

I-9602LW-LPG I-9602LW-NG

Addressable Gas Detector
- Liquefied Petroleum Gas
- Natural Gas

Overview

I-9602LW Addressable Gas Detector is used to detect leakage of home use combustible gas (LPG, Natural Gas) in such areas as houses, hotels and apartments. When leakage is detected, the detector will generate high buzzer alert sound, and provide a dry contact to turn exhaust fan, a 12VDC source to switch off the gas valve.

The addressable detector can be linked into GST fire alarm system to carry out intelligent control.



Specification

- Operating Voltage: 24VDC
- Alarm Threshold: LPG: 2000×10^{-6} (10%LEL)
NG: 3000×10^{-6} (6%LEL)
- Ingress Protection: IP30

C-9602LW-LPG C-9602LW-NG

Conventional Gas Detector
- Liquefied Petroleum Gas
- Natural Gas

Overview

C-9602LW Conventional Gas Detector is used to detect leakage of home use combustible gas (LPG, Natural Gas) in such areas as houses, hotels and apartments. When leakage is detected, the detector will generate high buzzer alert sound, and provide a dry contact to turn exhaust fan, a 12VDC source to switch off the gas valve.



Specification

- Operating Voltage: 220VAC 50/60Hz
- Alarm Threshold: LPG: 2000×10^{-6} (10%LEL)
NG: 3000×10^{-6} (6%LEL)
- Ingress Protection: IP30

Power Supply Unit

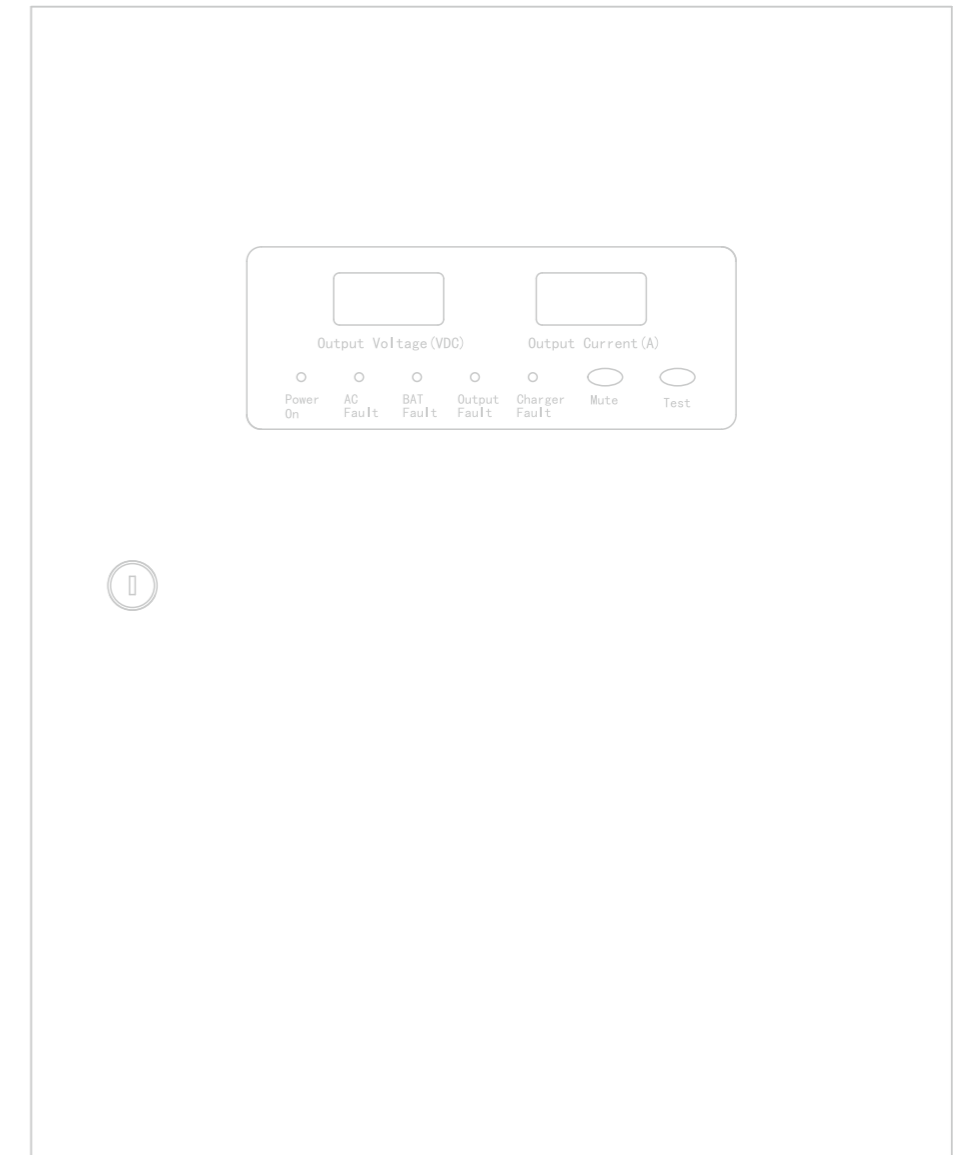

Power Supply Unit



PSU24-5 PSU24-5A

Intelligent Power Supply Unit

Overview

The PSU24-5/5A power supply unit is to support heavy consumption application, part of the fire alarm devices require for external 24VDC power supply. The supply source is 230 VAC, 50/60 Hz. Nominal output load is 5A/24VDC. The built-in charger and maintenance-free sealed lead acid batteries ensure the standby supply. PSU24-5A is also possible to be connected into fire alarm loop, so that to report fault of mains loose, battery loose or output broken to the fire panel.

Specification

- Mains Supply: 230VAC+10%/-15%, 50/60Hz
- Rated Output: 5A/26.5V DC
- Backup Battery: 12Ah/24VDC
- Dimension: 400mm×318mm×128mm



PSU24-10 PSU24-10A

Intelligent Power Supply Unit

Overview

The PSU24-10/10A power supply unit is to support heavy consumption application, part of the fire alarm devices require for external 24VDC power supply. The supply source is 110-230 VAC, 50/60 Hz. Nominal output load is 10A/24VDC. The built-in charger and maintenance-free sealed lead acid batteries ensure the standby supply. PSU24-10A is also possible to be connected into fire alarm loop, so that to report fault of mains loose, battery loose or output broken to the fire panel.

Specification

- Mains Supply: 110VAC ~ 230VAC, 50/60Hz
- Rated Output: 10A/26.5V DC
- Backup Battery: 24Ah/24VDC
- Dimension: 520mm×350mm×156mm

Specified Detector

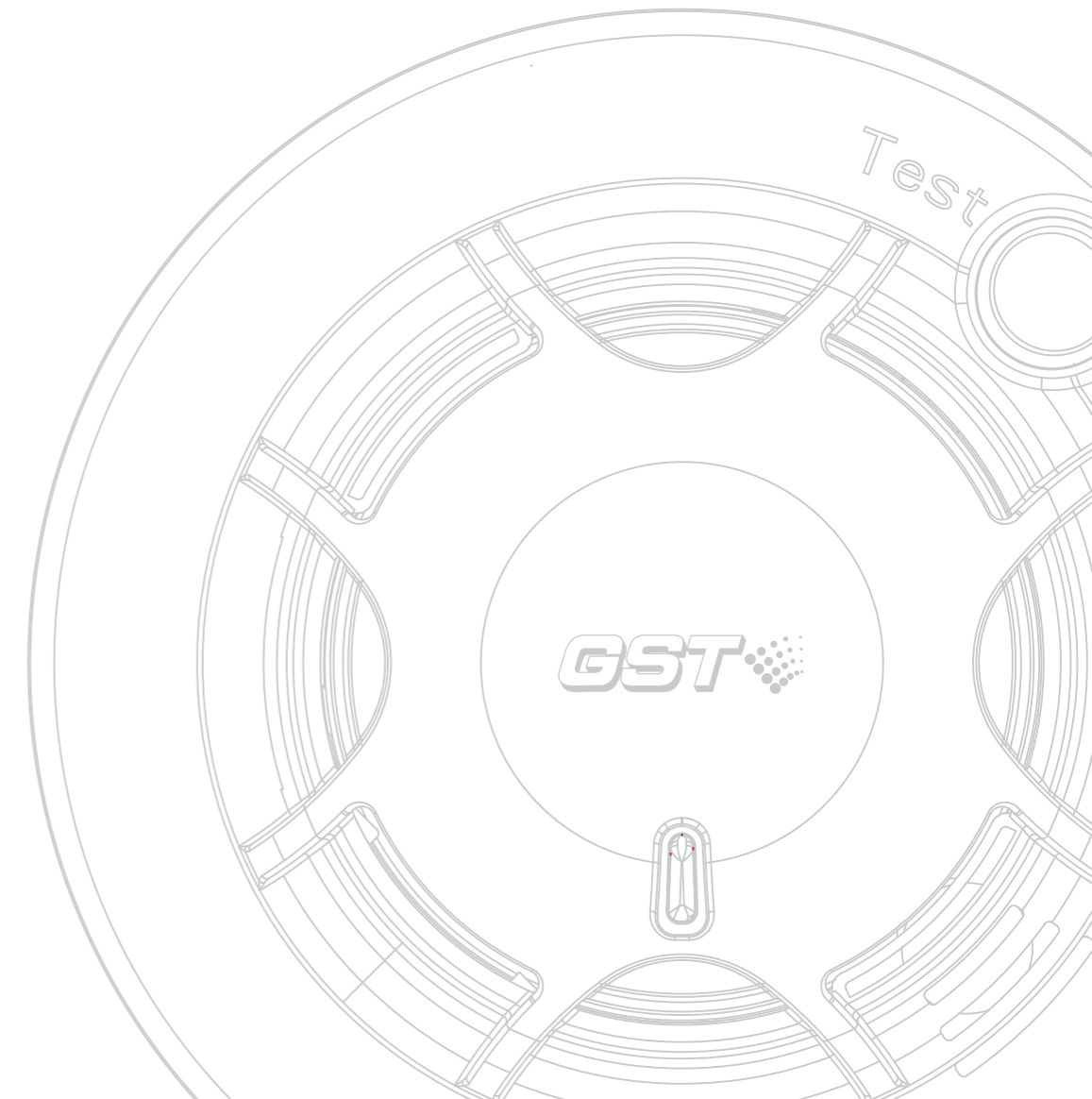

Value Added Unit



R6601

Conventional Smoke Detector

R6602

Conventional Heat Detector

Overview

The 4-wire type detectors are usually applied to security system, or standalone with relay output. Detector provides a normally-open contact, which will be closed when detector alarms.

Specification

- Operating Voltage: 12VDC (9.6VDC ~ 14.4VDC)
- Output Relay: 30VDC/1A
- Cabling Method: 4-wire, 2 for power, 2 for output
- Ingress Protection: IP23



S-9102R

S-9102N

Stand Alone Smoke Detector

Overview

Battery powered stand alone smoke detector, adapting optical chamber, to detect smoke produced by fire, gives high volume sound notification in case of alarm. It is suitable for small projects like home application, small shop, pub, and etc.

The S-9102R provides a polarized N/O contact output (photoelectrical isolated) for further application.

The S-9102N provides network function, suitable for group usage of the detector. All networked detectors will sound together when anyone of them alarms.

Specification

- Operating Voltage: 2-piece of AA LR6 alkaline batteries
- Battery Life: 3 years
- Detection Area: 60-100m²
- Alarm Sound: 80dB@3m

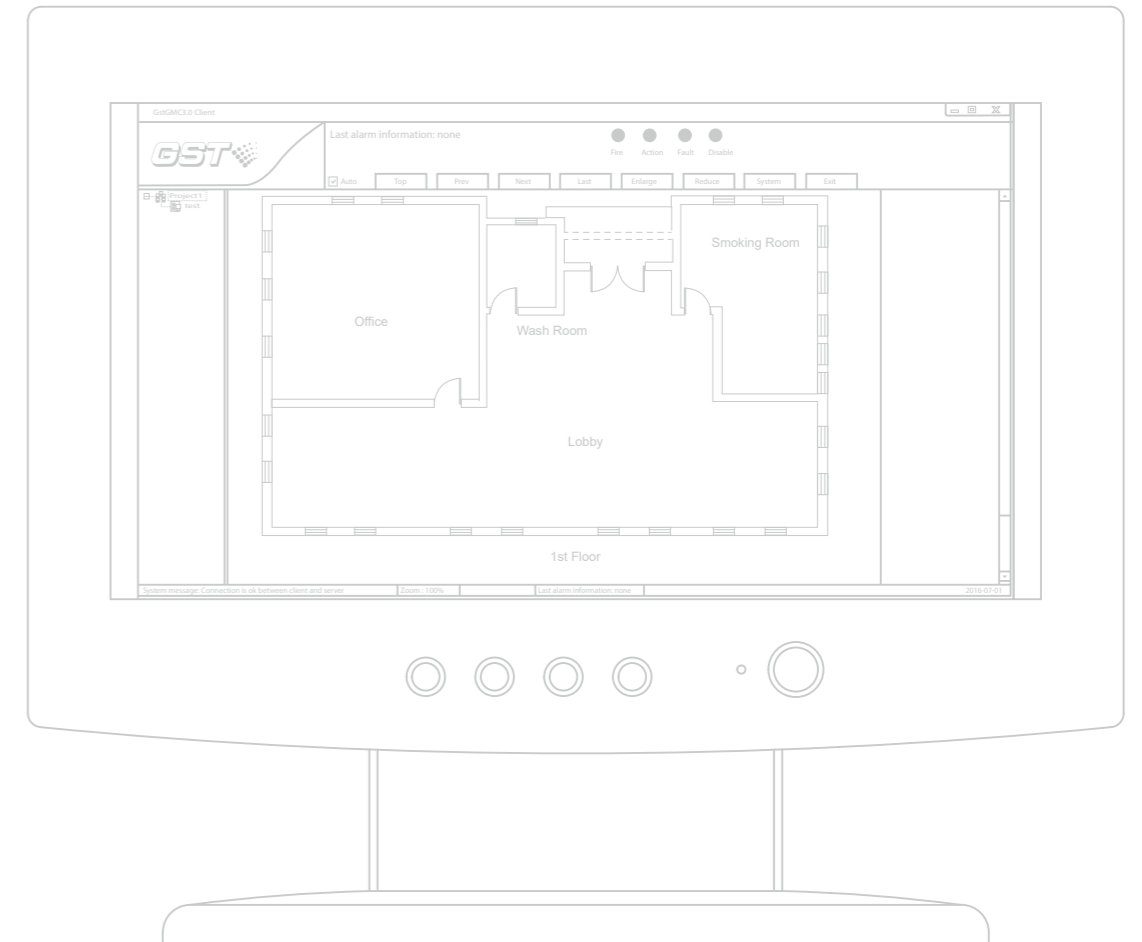



GST-GMC GST-IFPx-GMC-S/M/L

Graphic Monitor Center

Overview

GstGMC3.0 Graphic Monitor Centre is a fire alarm system monitoring software. With friendly interface, the software supports 8 remote client stations plus local monitor station, making complete monitoring and control. With OLE for Process Control (OPC), the communication with fire alarm control panel can also be integrated into other systems. It can be used with GST200N and GST-IFP8 series panels.

GST-IFPx-GMC-S/M/L Graphic Monitor Centre is a fire alarm system monitoring software. With friendly interface, it displays with device icons and text window supporting maximum 10 clients station, making complete monitoring and control. It has 3 models to satisfy different projects from less than 500, between 500-2000 and more than 2000 addresses. This software can be used with GST-IFPX series panels. Different with GstGMC3.0, it is licensed by a dongle key.

Hardware Requirement

CPU: Pentium III 1G or above
Minimum free Hard disk: 10GB
Memory: 2GB or above

Operation System

Windows 7, Windows 10(IE8.0 or above)
GST-GMC also can be operated in Windows XP Professional (IE6.0 or above)



DEF-KEY DEF-KEY-TIMER

USB Dongle

Overview

A sort of CPU or smart card based security device, to protect definition database of DEF software and panel project configuration data. Unauthorized person without the dongle key is not possible to start the software (DEF3.0) or create communication between Def software and panel

System Diagram

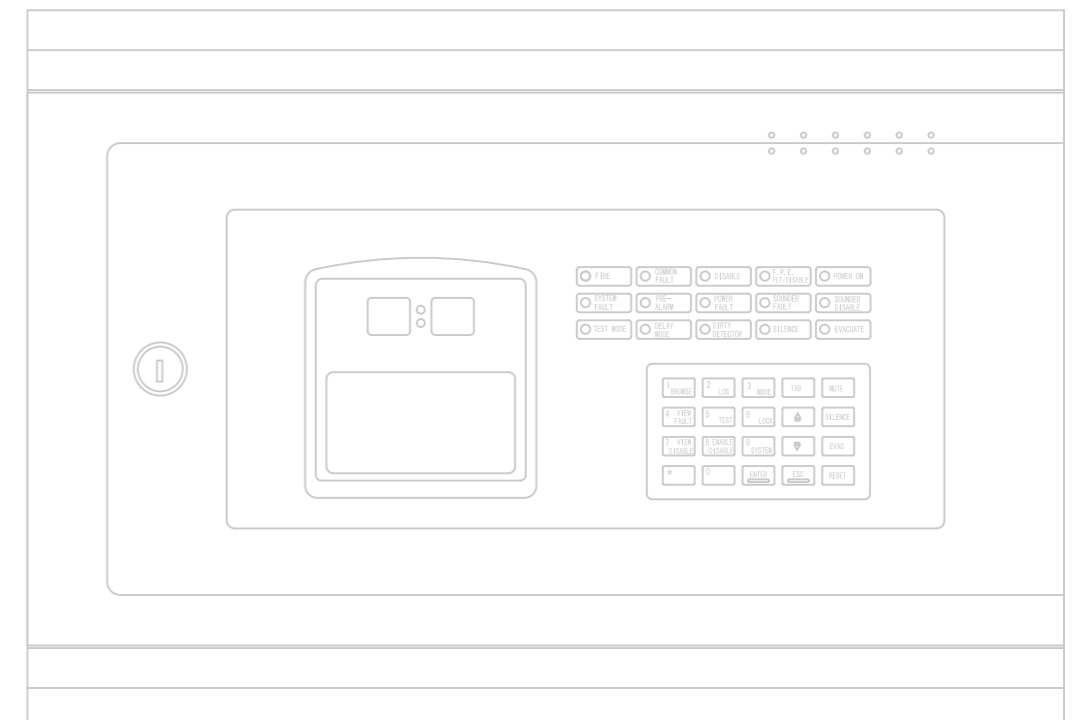

EN Product System Diagram

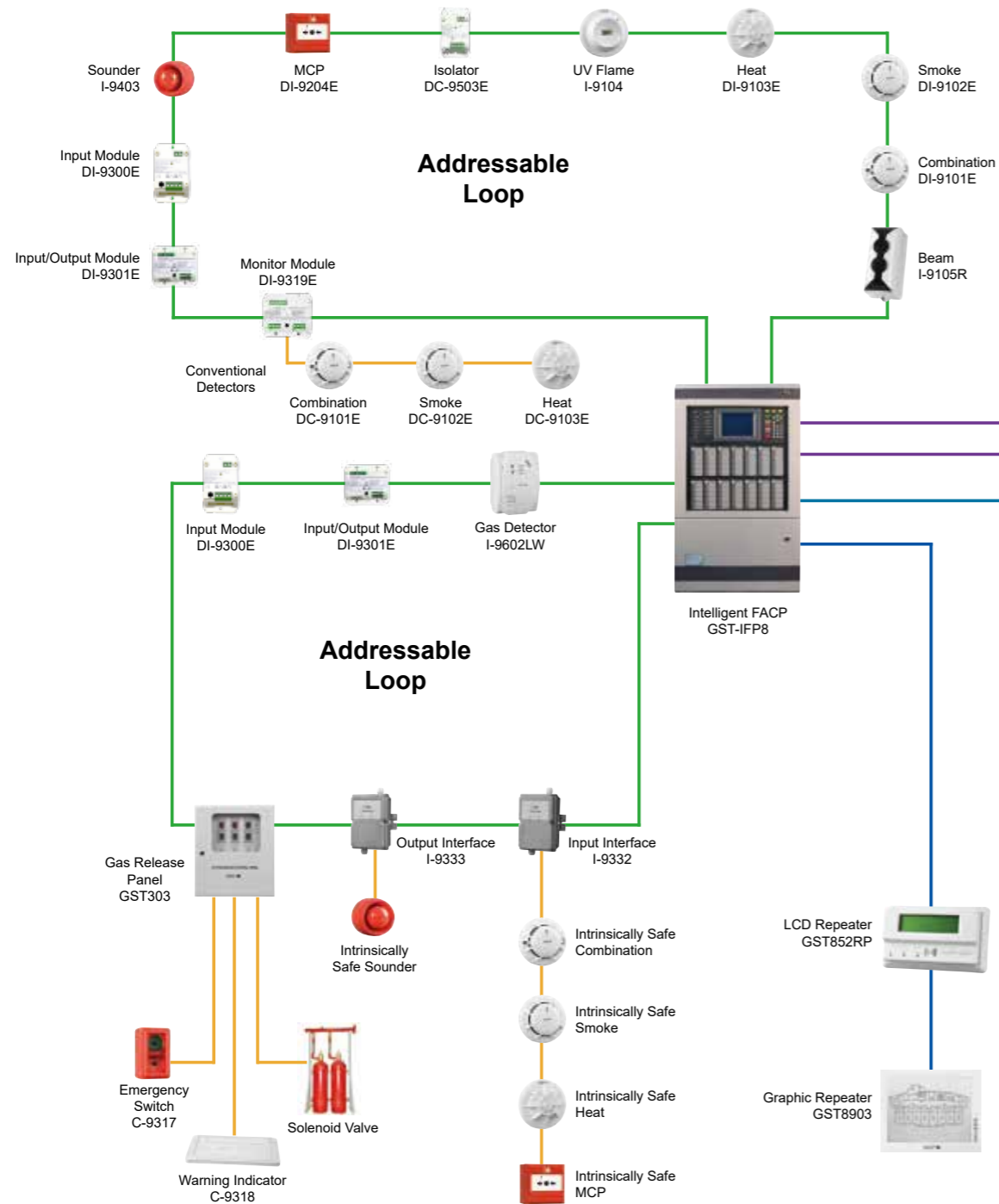

EN Product System Diagram

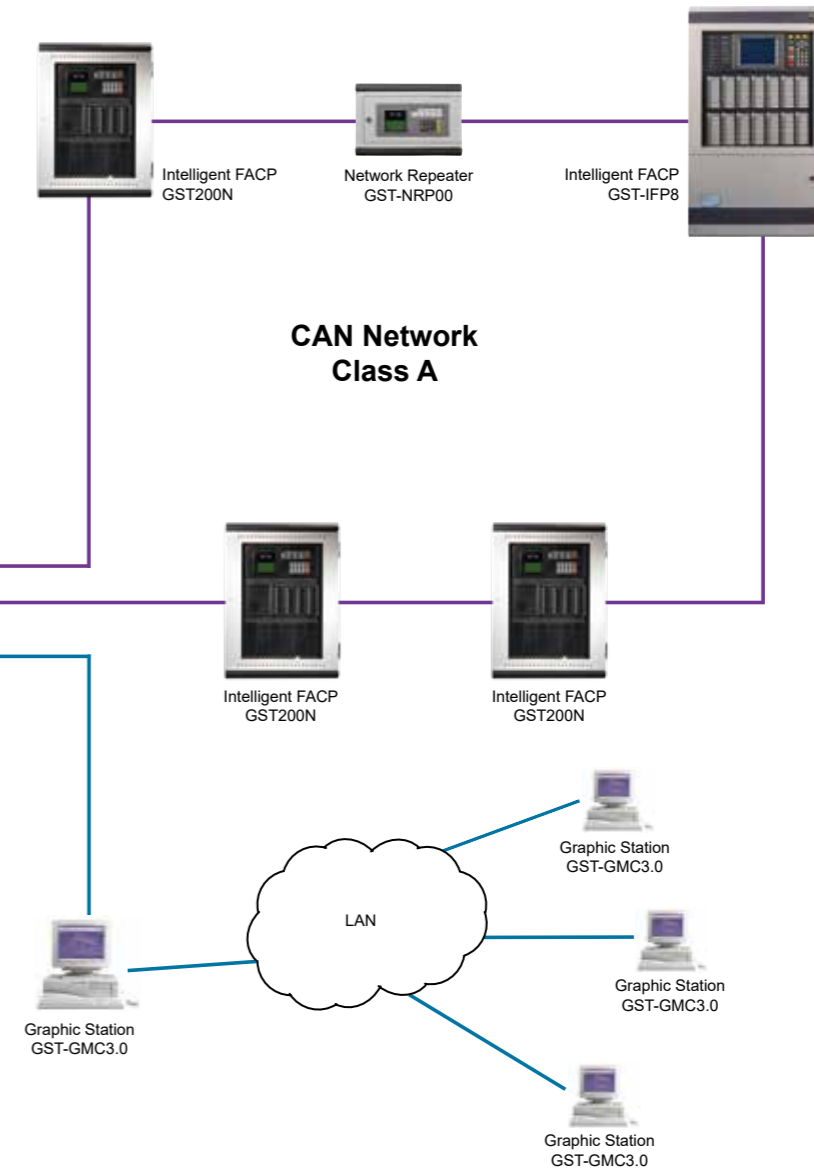

- CAN Network is possible to be Class A , Class B or Star Topology. Suitable network cards and accessories are available.
- External 24VDC Power Supply may be required by some devices.
- Max. 8 Remote Users can be connected to the host PC through LAN

UL Product System Diagram

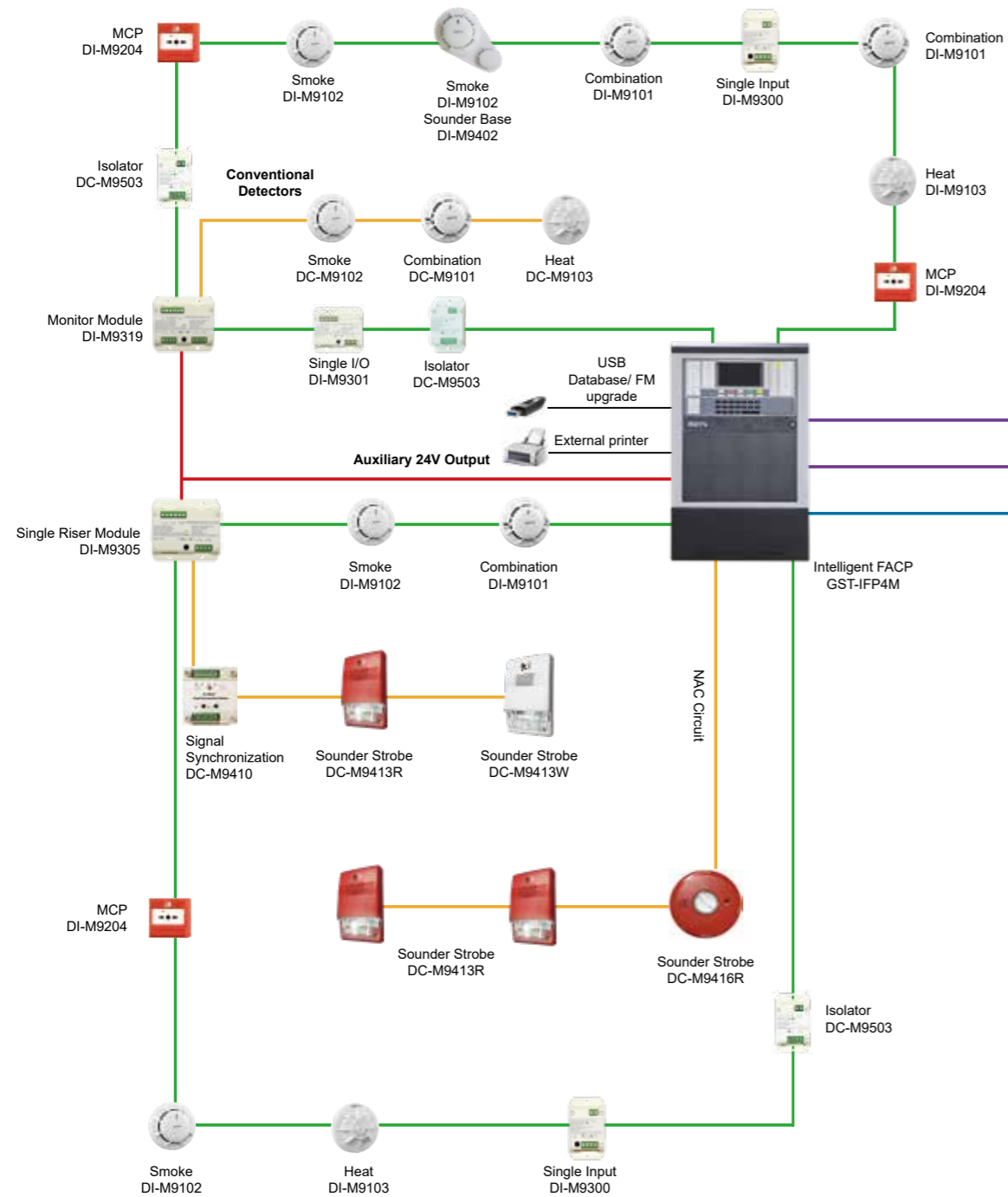

UL Product System Diagram

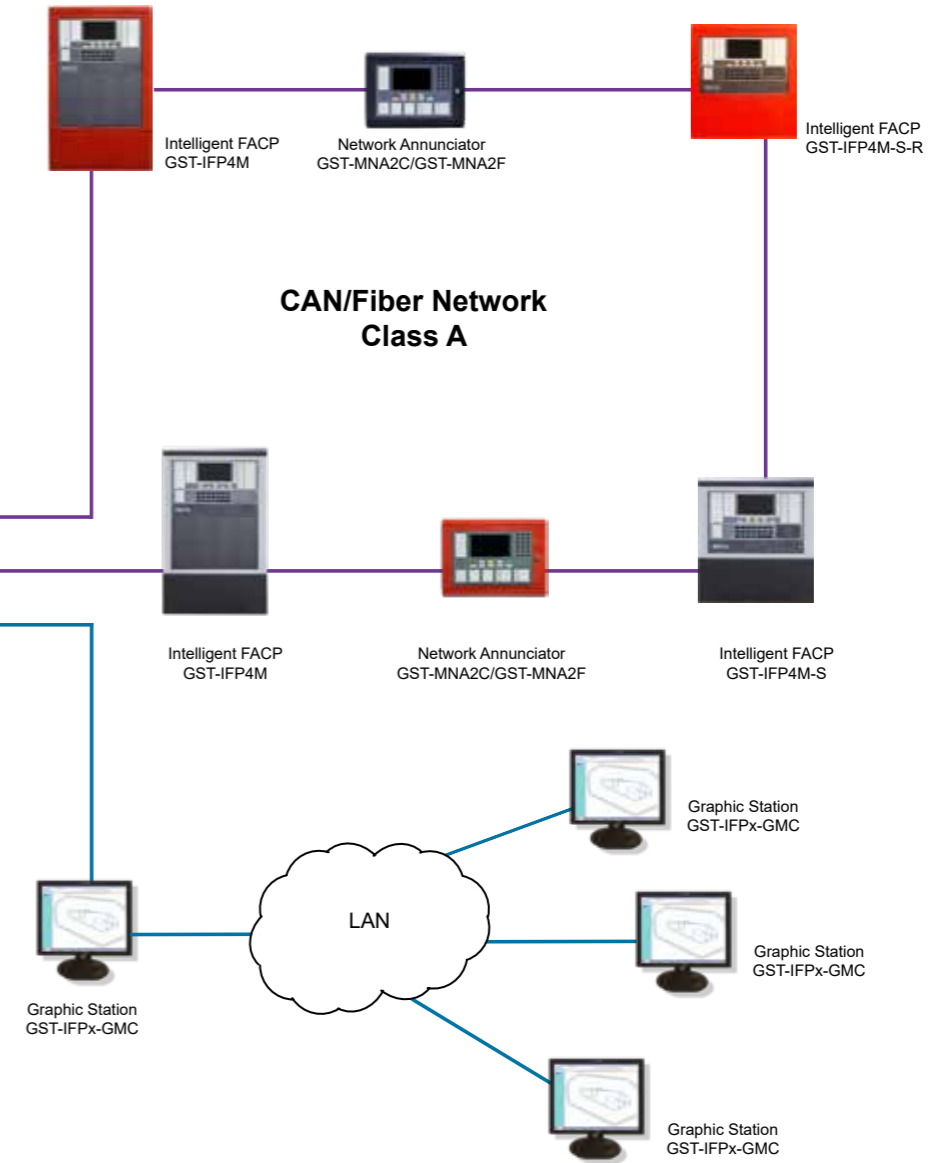

- Need additional CAN/Fiber network card to be installed into panel for networking, maximum networking capacity 250 Panels and network annunciators.
- Maximum 10 Remote Users can be connected to the host PC through LAN.
- Maximum output of Panel NAC+ Auxiliary output is 2.5A

Emergency Voice Evacuation

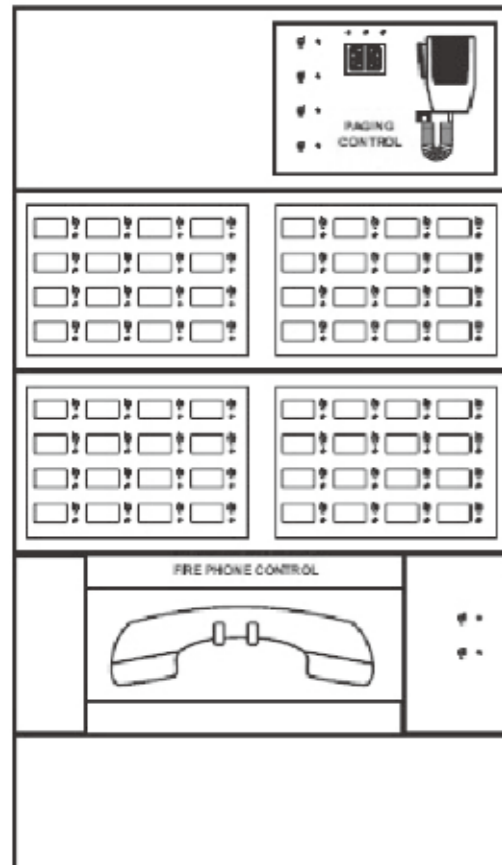

Emergency Voice Evacuation System



GST-VES

Emergency Voice Evacuation System

Description

GST Voice Evacuation System (GST-VES) is used to make emergency voice announcements to people inside a building. The system operates when a fire condition is detected, telling people to evacuate from the building. The GST-VES equipment meets National Fire Protection Association (NFPA) standard and is UL listed. Accomplished with a microphone, amplifier, and speakers, the building manager or fire department keys the microphone and broadcasts instructions in emergency condition. The GST-VES system consist one GST-MP panel and several GST-DP panels. The GST-MP Master Panel operates in conjunction with the Fire Alarm Control Panel (FACP) in a building to provide an automatic response to life safety emergencies. The GST-MP includes all the necessary features to provide an effective voice evacuation system. The GST-MP can be custom configured to satisfy the needs of any high rise application. The GST-MP system includes capacity for 6 channels of simultaneous audio. This provides for evacuation, alert stay-in-place, or other public address announcements and automatic messages.

GST-DP Distributed Panel is connected to GST-MP in a voice evacuation system, receiving the command and voice signal from GST-MP, amplifying, and to provide 25V or 70V audio source to the speaker directly. GST-DP may be located either in the fire alarm control room or distributed on the floors in the building where is closer to the speakers.

Features

- True Multiplex 6 Channel Audio
- Integrated Fire Phone
- Integrated 2 Channel Digital Message Repeater
- Live Microphone Page to any zone
- Fast RS-485 Communication Protocol
- Fully Supervised
- Easy Installation and Operation
- Natural Sound Voice Recordings
- Built in Alarm and Alert Signals
- Up to 4 Minute Message Capacity
- Integrates with GST Fire Alarm Panel
- Interfaces with non GST Addressable and Microprocessor based Fire Alarm Panels
- 2 Minute Message Restart on Microphone Key

System Components



GST-MP

Master Panel

GST-MP is the Master Panel of GST voice evacuation system. The GST-MP provides the operating interface, control and audio signals, and supervision to the distributed panels. GST-MP also provides interface to the FACP either by RS232 or dry contact. GST provides two models of basic master panels. GST-MP16 has all basic features with 16 switches/LEDs and 16 inputs for FACP. GST-MP16x is same as GST-MP16 without cabinet. Both GST-MP16 and GST-MP16x does not include the fire phone. You may order the accessories to add fire phone, more switch/LED and input as you desire. GST-MP16 can be mounted next to the fire alarm control panel, and GST-MP16x shall be mounted into GST-IFP8-VT fire alarm control panel.

GST-DP

Distributed Panel

GST-DP is the Distributed Panels in the system. All GST-DP are connected to a master panel via RS485 line and provide the supervised 25V or 70V speaker circuit and fire phone circuits on the fields. Each GST-DP is powered individually and with backup battery. GST provides 4 basic models: GST-DPS50, single channel, 50W GST-DP50, dual channel, 50W GST-DPS100, single channel, 100W GST-DP100, dual channel, 100W All these models have 4 class B circuits, and do not have the fire phone option. All these models can be expanded for 4 to 16 fire phone circuits. 4 class A or 8 class B speaker circuit.

GST-IFP8-VT

The GST-IFP8-VT is the intelligent fire alarm control panel (FACP) in the emergency voice evacuation system. In a situation of fire the FACP triggers the GST-MP and GST-DP to activate the evacuation alarm automatically. The connection between FACP and GST-MP may be RS232 or hard wired digital input. GST-IFP8-VT is built for integrated with GST-MP16x to form a single panel for both fire alarm control and voice evacuation controls. GST-IFP8-VT may have max 8 loops, with 242 addresses on each loop. The FACP can also link to other fire alarm control panel to form fire alarm panel network.

System Components

MFP

Master Fire Phone Card

Accessory on master panel for fire phone. Add 1 MFP to GST-MP16 or GST-MP16X if the fire phone is required.



GST-MFH-A

Master Fire Phone Handset Assembly

Accessory on master panel for fire phone. Add 1 MFH to GST-MP16 or GST-MP16X if the fire phone is required.



SLC

Switch LED Card

Accessory on master panel. One SLC card provides 16 switches and LED's for manual control at Master Panel. Add SLC cards if more than 16 switch/LED are required.



SSC

Switch Scan Card

Accessory on master panel. Each SSC card controls up to 8 switch/LED cards. One SSC card is included in the basic GST-MT master panel.



System Components

GST-XI

Extended Input Interface card

Accessory on master panel. One XI card provides 16 additional inputs to master panel. Maximum 7 XI can be connected to one II card.



MBK

Mother Board Relays

One MBK card provides 4 class "B" speaker circuits. And two MBK cards provide 8 "class B" or 4 "class A" speaker circuits in one distributed panel. One MBK card is included in basic GST-DP panel.



FPI

Fire Phone Interface

Each FPI provides 4 supervised class "B" fire phone circuits in DP panel. Maximum 2 FPI (8 phone circuits) can be installed in one GST-DP.

System Components

GVX-BA

Backup amplifier switching relay

One required for each Distributed Amp when automatic switching /redundant amplification is needed.

On a single Channel system the backup amplifier can be located in any GST- DP panel. On a Dual Channel system an additional AMI card, and EVX #E Amplifier assembly is required (the # represents the largest power amplifier in the system 50/100).



FPO2

Fire Phone Interface Terminal

One FPO2 provides 4 additional terminals for fire phone circuits. It is required for the 2nd, 3rd and 4th FPI Fire Phone Interface in GST-DP.



GVX-50E / GVX-100E

Amplifier Module

GVX-50E is 50W amplifier module and GVX-100E is amplifier module. The amplifier module is included in basic GST-DP. Amplifier module may be ordered as spare or adding extra output power to GST-DP. Max 2 amplifier modules can be mounted in one GST-DP.



XFMR

Transformer

This transformer is for amplifier module. 220VAC, 50Hz. It is required if additional amplifier is added to GST-DP.



System Components

P-9935EVAX

Communication Card

This card provides interface between GST-IFP8-VT FACP and GST-MP via RS232 port. It is not required if the dry contact interface is employed.



Configuration and Order Information

Part No.	Product Description	Default QTY	Max. QTY	Remark
GST-MP16	Master panel, with 16 inputs, 16 Switches/EDs, with Cabinet	N/A	N/A	N/A
GST-MP16x	Master panel, with 16 inputs, 16 Switches/EDs, without Cabinet	N/A	N/A	N/A
GST-DP50	Distributed panel, Dual channels 50 Watts, 4 Class B speaker circuits	N/A	N/A	N/A
GST-DPS50	Distributed panel, Single channel 50 Watts, 4 Class B speaker circuits	N/A	N/A	N/A
GST-DP100	Distributed panel, Dual channels 100 Watts, 4 Class B speaker circuits	N/A	N/A	N/A
GST-DPS100	Distributed panel, Single channel 100 Watts, 4 Class B speaker circuits	N/A	N/A	N/A
SLC	Switch LED Card	1 ⁽¹⁾⁽²⁾	64	Optional components for Master Panel, More than 16 switches and LED's required, another SLC is needed
SSC	Switch Scan Card	1 ⁽¹⁾⁽²⁾	8	Optional components for Master Panel ,Every 8 SLC needs one SSC
MFP	Master Fire Phone Card	0	1	Optional components for MP
GST-MFH-A	Master Fire Phone Handset Assembly	0	1	Optional components for MP
FPI	Fire Phone Interface	0	4	Optional components for Distributed Panel, 4 supervised Class "B" Fire Phone circuits per FPI
FPO2	Fire Phone Output Adapter	0	3	Optional components for Distributed Panel, More than 1 FPI is required in a Distributed Panel, one FPO2 card is needed for each
GVX-50E	Amplifier Module	1 ⁽⁴⁾ 2 ⁽³⁾	1 ⁽⁴⁾ 2 ⁽³⁾	Optional components for GST-DPS50, if converts from GST-DPS50 to GST-DP50,one GVX-50E is needed
GVX-100E	Amplifier Module	1 ⁽⁶⁾ 2 ⁽⁵⁾	1 ⁽⁶⁾ 2 ⁽⁵⁾	Optional components for GST-DPS100, if converts from GST-DPS100 to GST-DP100,one GVX-100E is needed
MBK	Mother Board Relays	1 ⁽³⁾⁽⁴⁾⁽⁵⁾⁽⁶⁾	2	Optional components for Distributed Panel, One additional MBK needed for 8 Class "B" or 4 Class "A" Speaker Circuits on Distributed Panel.
P-9935EVAX	RS232 Communication Card	0	1	Interface card between GST-IFP8 or GST-IFP8-VT and Master panel, Provides communication between GST-IFP8 panel and GST-MP
XFMR	Transformer	1 ⁽⁴⁾ (6) 2 ⁽³⁾ (5)	1 ⁽⁴⁾ (6) 2 ⁽³⁾ (5)	Optional components for convert single channel Distributed panel to dual channels Distributed panel. One transformer required per amplifier
XI	Extended Input Interface	0	7	Optional components for Mater panel, connect, connect with II Input Interface card, provides additional 16 inputs per XI card

⁽¹⁾ Configuration for GST-MP16

⁽²⁾ Configuration for GST-MP16x

⁽³⁾ Configuration for GST-DP50

⁽⁴⁾ Configuration for GST-DPS50

⁽⁵⁾ Configuration for GST-DP100

⁽⁶⁾ Configuration for GST-DPS100

Technical Specification:

- Communications: RS-485 Standard, 1M Baud rate
- Primary Supply: 220VAC
- Backup Battery: 7AH/24VDC(GST-MP), 17AH/24VDC(GST-DP)
- Electrical Ratings: All Circuits @ 24VDC
- End of Line Resistor: 10kΩ
- Maximum Cable Length: 4,000 feet, #16 AWG, between panels, 50,000 feet in the overall system.
- Recommended Cable: 16 or 18 AWG, (Low Capacitance) UTP Unshielded-Twisted pair.

GST-VES system diagram

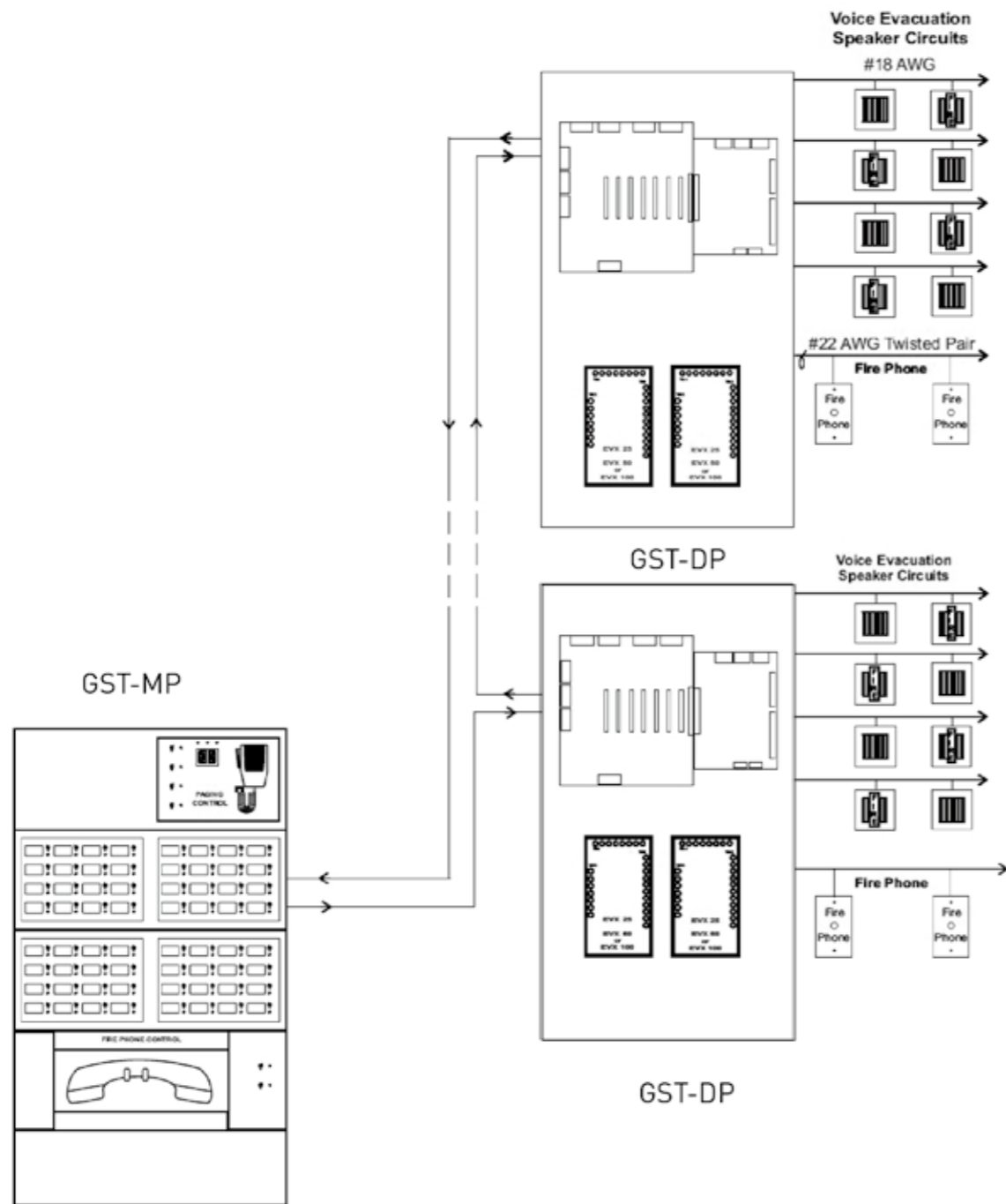

System Diagram - GST-VES with GST-IFP8-VT

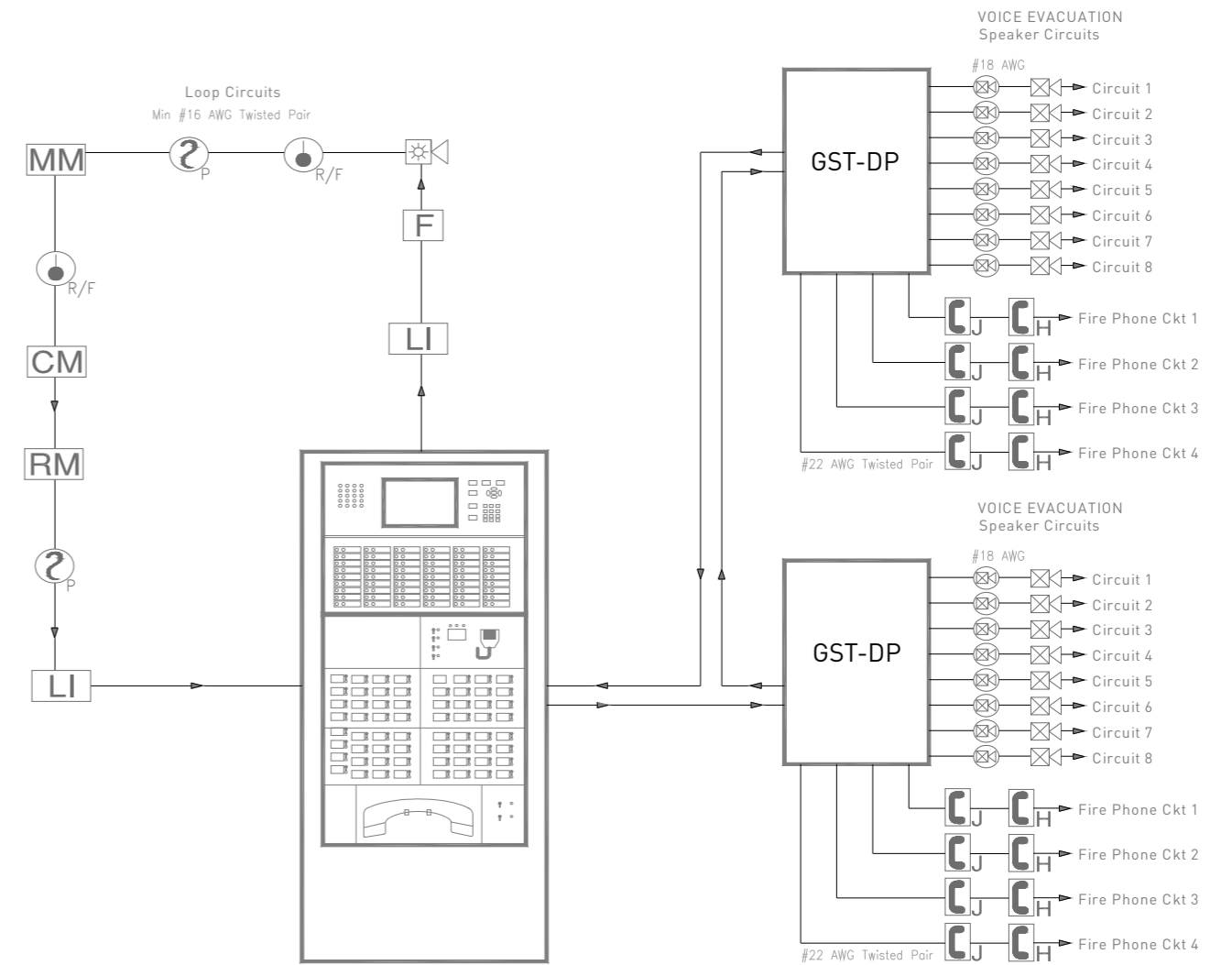

Emergency Telephone Products

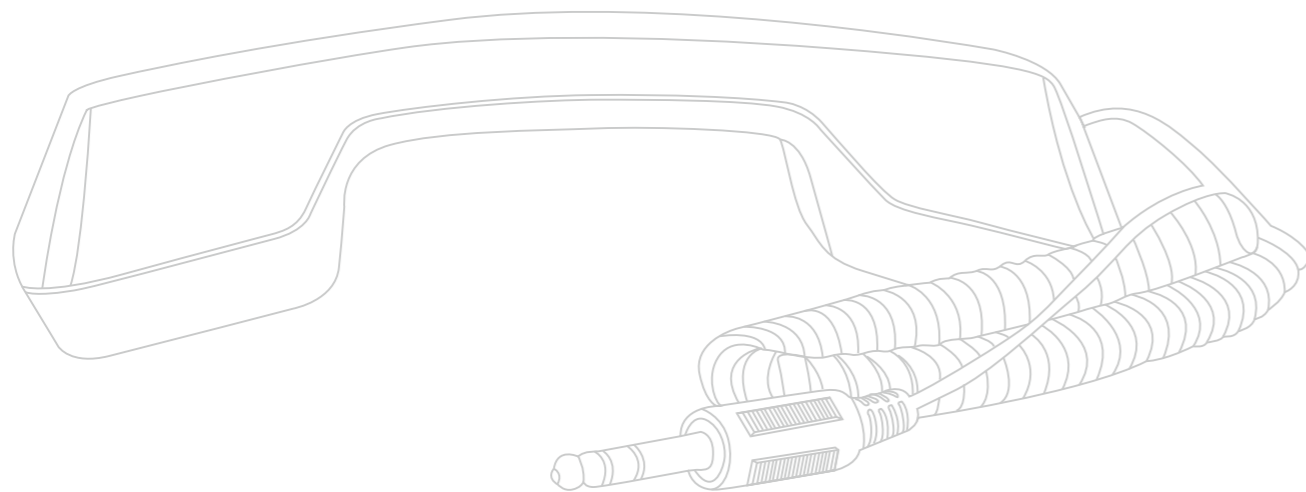

Emergency Telephone Products

GST-FT8WN

Fire Telephone Panel

Overview

GST-FT8WN fire telephone panel is conventional model, specialized for emergency communication. The panel is networkable up to 8 panels. Call from handset will be transferred to networked fire telephone panels automatically after not answered by the dedicated panel. Each zone is fully monitored of cable fault. Failure of one zone will not effect on other zones.

Specification

- Mains supply: 24VDC
- Zone Capacity: 8
- Installation Method: Wall-mount
- Handset Capacity: 3 fixed handsets or 10 sockets
- Dimension: 400mm x 280mm x 100mm



GST-FT24N

Fire Telephone Panel

Overview

GST-FT24N fire telephone panel is conventional model, specialized for emergency communication. The panel is networkable up to 8 panels. Call from handset will be transferred to networked fire telephone panels automatically after not answered by the dedicated panel. Each zone is fully monitored of cable fault. Failure of one zone will not effect on other zones.

Specification

- Mains supply: 24VDC
- Zone Capacity: 24
- Installation Method: 19" Rack-mount
- Handset Capacity: 3 fixed handsets or 10 sockets
- Dimension: 482.5mm x 132.5mm x 225mm





P-9911(H)

Handsfree Speaker Fire Telephone

The P-9911(H) handset is wall mounted, compatible with GST-FT series of fire telephone panels, for emergency communication over a dedicated hard wired system normally located with the fire command centre.

Dimension: 160mm x 80mm x 35mm



P-9911(F)

Fixed Fire Telephone Handset

The fixed handset is wall mounted, compatible with GST-FT series of fire telephone panels. The unit should be mounted in a suitable and dry location at about 1.5m from finished floor level.

Dimension: 234mm x 146mm x 60mm



P-9911(M)

Mobile Fire Telephone Handset

P-9911(M) is a mobile type emergency telephone handset, which can be taken by the security guard, fireman or others on duty. The person can go to the nearest jack sockets, plug and talk to the central GST-FT series of fire telephone panels located in the command center.

Usually 2-5 handsets are recommended according to amount of telephone sockets.



P-9911(J)

Fire Telephone Jack

P-9911(J) telephone socket normally locates at the landing levels of all core stairwells and escape routes. The person on site with a mobile handset may just plug & talk to the control center. The unit should be mounted in a suitable and dry location at about 1.5m from finished floor level.

Dimension: 85mm x 85mm x 12mm

IMPORTANT: This publication is a generic version in which product information is shown for informational purposes only and does not constitute a specific commitment or guarantee. We are constantly pursuing the improvement of product technology to improve product performance, for which we reserve the right to adjust the configuration and technical information of the related products without notice. In addition, the description of system performance in this publication applies only to the usual situation. As a result, there may be a variety of unpredictable special circumstances in the real world, so the realization of the relevant product performance will depend on the professional investigation and analysis and the design plan. Please contact us and we will be happy to provide you with professional advice.



EMEA Headquarters

Carrier Fire & Security EMEA BVBA
(Europe, Middle East & Africa)
Pegasus Park - De Kleetlaan 3 1831
Diegem · Brussels, Belgium
Tel: +32 (0)2 725 1120
Fax: +32 (0)2 721 4047
E-mail: emea@carrier.com

South East Asia

Carrier Fire & Security Singapore Pte Ltd
Add: 28 Teban Gardens Crescent, Singapore
608926
Tel: (65) 6506 1616
Fax: (65) 6298 7310
Email: Vietnam: Tuan.Truong@carrier.com;
Others: wenbinn.teoh@carrier.com

HONG KONG

Chubb Hong Kong Limited
Add: 10/F, Octa Tower, 8 Lam Chak Street,
Kowloon Bay, Kowloon, Hong Kong
Tel: +852 2705-8800
Fax: +852 2765-8014
E-mail: fire@chubb.com.hk

TAIWAN

Carrier Fire & Security Ltd., Taiwan
Add: 15F., No.156, Sec. 1, Zhongshan Rd.,
Banqiao Dist., New Taipei City 220, Taiwan
Tel: +886 2 8964 3777 ext. 3236
E-mail: hsuan.liu@carrier.com

MEA

Carrier Fire & Security Products
Add: PO Box 30791 Palladium Building 203 & 209
Dubai, United Arab Emirates
Tel. +971 4 4199000
E-mail: marketingme@carrier.com

INDIA

Carrier Fire & Security India Ltd.
Add: 3rd Floor, Block 3, Prestige Blue Chip #9,
Hosur Road, Bangalore -560029, India
Tel: +91-080-43442000
E-mail: central.communications@carrier.com

Gulf Security Technology Co.,Ltd Carrier Global Corporation (Carrier)

12F, Building A, New Bund World Trade Center(I), No.4, Lane 255,
Dong Yu Rd, Shanghai 200126, China

ASIA: Tel: +86 21 38938223 Email: asiasales.gst@carrier.com

EMEA: Tel: +86 21 38938219 Email: emeasales.gst@carrier.com

LA & ANZ: Tel: +86 21 38938217 Email: lasales.gst@carrier.com

China's Contracted Projects Overseas (Chinese spoken only):

Tel: +86 10 65540785 Email: overseasales.gst@carrier.com

<https://www.gst.com.cn/en/> www.corporate.carrier.com

Version 202102

© 2021 Gulf Security Technology Co., Ltd

